

20X/30X D/N HD Fast Dome IP CAMERA

Installation Guide

66-PSD462CSB-3



Warning: Do not throw your product in municipal waste. This product has been designed to enable proper reuse of parts and recycling. The symbol of the crossed out wheeled bin indicates that the product (electrical and electronic equipment) should not be placed in municipal waste. Check local regulation for disposal of electronics products.

Part Description & Dimensions

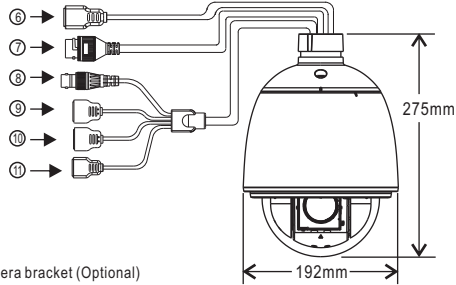

- ① Camera bracket (Optional)
- ② Camera bracket base (Optional)
- ③ Camera quick release adaptor
- ④ Camera body
- ⑤ Micro SD Card Slot

For preventing fall risk, the PTZ camera must be taken down and the SD card is inserted while the PTZ camera is on the ground

- ⑥ AC24V/DC24V Power Cable

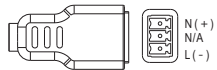

- ⑦ RJ-45 Network Cable
- ⑧ Video Out BNC Jack
Video Signal Output CVBS 1.0Vp-p 75Ω BNC
- ⑨ Alarm In Cable (Alarm Input Voltage: 5.6V max)

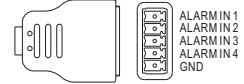

- ⑩ Alarm Out Cable (Alarm Output: DC40V, 300mA max.)

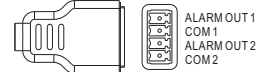

- ⑪ Audio In/Out Cable & RS-485 -/+ Cable
Audio: 1.98Vp-p max.

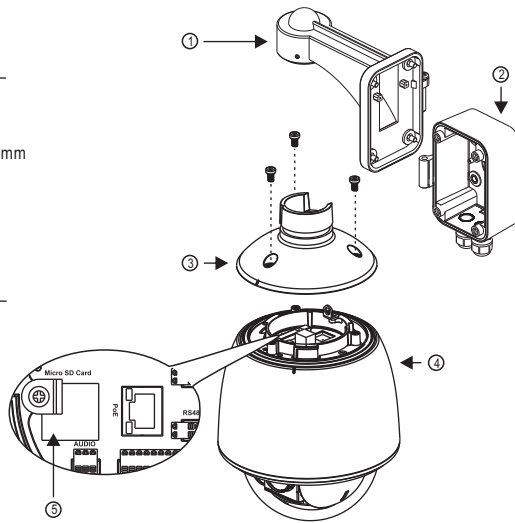
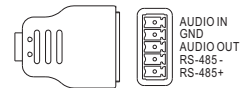

- **Step 2** Secure the bracket base to the wall
Attach the installation sticker to the wall and drill four holes according to the instructions (FIG.3). Tighten four bolts to secure the base to the wall (FIG. 4). To use the central hole on the base, first hammer the lid off (FIG.5).
Note:

1. The recommended length of the wall-mounted screw is 1.5"(38.1mm) or more
2. The bolts are not included in the package.

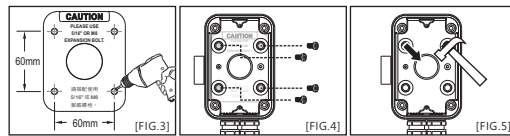

- **Step 3** Attach the safety strap & camera body to the bracket
Slip the safety strap & control wires through the bracket (FIG.6). Align the adaptor with the bracket before tightening the bracket bolts (FIG.7). Then slide the camera body and bracket together down the hinge to connect to the base (FIG.8).

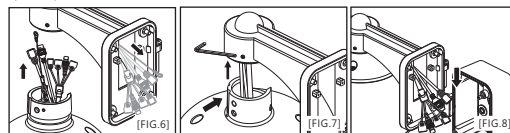

- **Step 4** Secure the safety strap and connect the control wires
To prevent the camera from falling, you should first secure the safety strap. Properly secure the safety strap to the bracket (FIG.9), and connect the AC24V/DC12V power connector, RJ-45 cable and control wire (FIG.10).

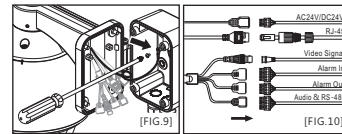
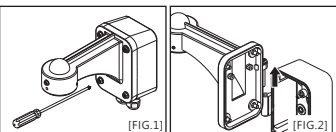

- **Step 5** Finish the installation
Secure the bracket to the base (FIG.11) and finish the installation (FIG.12).
Note: After completing the installation of the dome camera, lock the safety screw on the camera bracket to avoid falling (FIG.13).

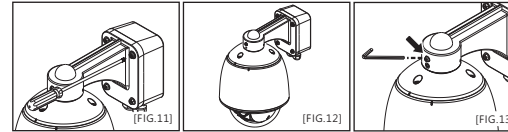

Low Temperature Power-Up

Camera may perform abnormally at low temperature. Hence, follow the below procedure when the camera is off due to power outage or other issues and needs to be restarted under -40°C to -5°C.

Low temperature power-up procedure

Power up and wait for the heater to warm up for 1 hour before you operate the camera.

Before Accessing IP Cameras

Before accessing the IP camera, make sure that the camera's RJ-45 network, audio, and power cables are properly connected. To set the IP address, consult your network administrator for an available IP address. The default IP address for each IP camera is 192.168.0.200. Users can use the default IP address for verifying the camera's network connection.

Software Requirements

Universal ActiveX software components are required for web interface display of JPEG or Full HD video. When you login to the IP camera by Internet Explorer, the security warning dialog box will prompt the installation of the Universal ActiveX. Click **Install** to download it.

Emergency Factory Default

To restore the hardware to factory default settings, please follow these steps:

1. Press and hold "RESET Key" for 10 seconds and release.
2. Wait for about 40 seconds, and the network LED light should turn off, and go back on again.
3. The camera is now restored to factory default settings, and will reboot automatically.
4. Search for the IP device using the IPScan software.
5. Start the IP device via an Internet browser.
6. Enter the username and password to operate.

NOTE1: The factory default username and password are empty, and the user can set an account for login.

NOTE2: The IP address will revert to the default setting of 192.168.0.200.

Configuring IP Addresses via Web Interface

- To change an IP address via web interface, type the default IP address (192.168.0.200) in the Internet browser and follow the steps below:
1. Login to the Full HD IP camera with the set username and password.
 2. Click **Basic Mode** configuration hyperlink.
 3. Click **Network->General** hyperlink.
 4. Change the IP address, subnet mask, gateway, or HTTP port for the IP camera.
 5. Click **Submit** to verify the settings.

Configuring IP Addresses with IPScan Software

To change the settings of the IP address, subnet mask, gateway, or HTTP port, you can follow the steps below:

1. Run the IPScan software.
2. Click **Refresh**. All available devices should be listed in the device list.
3. Select your device from the list provided.
4. Change the IP address, subnet mask, gateway, or HTTP port for the IP camera.
5. Click **Apply** to submit the settings.
6. Click **Refresh** to verify the settings.

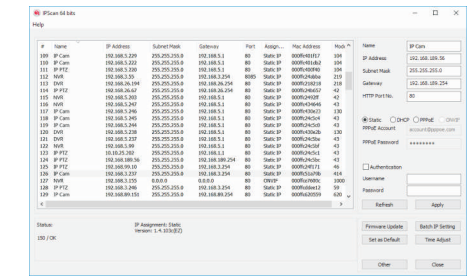

Login

The factory default username and password are empty. To login to the Full HD IP camera, please set the username and password on the login page. Press [Login] to complete the setting and login simultaneously.

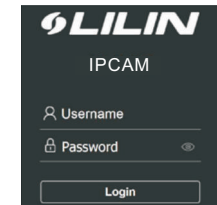

Password have to meet the following criteria:

1. More than or equal to 8 characters.
2. Allow uppercase letter, lowercase letter, number digit, and special character.
3. Must have at least three types of character sets.

警告：此圖示，指在廢棄產品時不可直接丟棄廢棄桶，應進行拆解，並分類進行回收再利用。



部件說明及尺寸

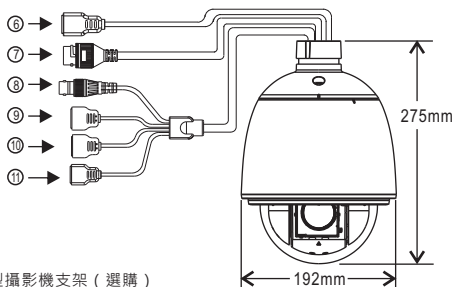

- ⑥ 球型攝影機支架 (選購)
- ⑦ 球型攝影機支架底座 (選購)
- ⑧ 球型攝影機快拆轉盤
- ⑨ 球型攝影機主體
- ⑩ Micro SD卡插槽：支援Micro SD及SDHC卡
為避免墜落危險，請於地面安裝SD卡
- ⑪ AC24V/DC24V電源端子



- ⑦ RJ-45網路連接端子
- ⑧ 影像輸出端子 (Video Out)
影像信號輸出 CVBS 1.0Vp-p 75Ω BNC
- ⑨ 警報輸入端子 (警報輸入點電壓5.6Vmax)



- ⑩ 警報輸出端子 (警報輸出規格DC40V, 300mA max.)

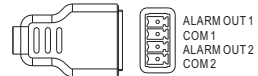

- ⑪ 聲音輸入/輸出端子 & RS-485連接端子
(Audio In/Out & RS-485 +/-)
聲音信號：1.98Vp-p max.

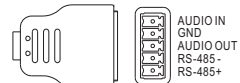

安裝

- 步驟1 將支架與支架底座拆開
將4顆螺絲由支架底座轉開 (圖1)，再將支架由門栓處往上推與支架底座分離 (圖2)。

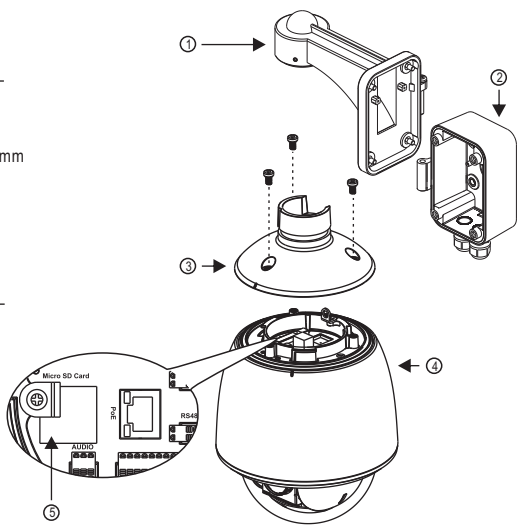
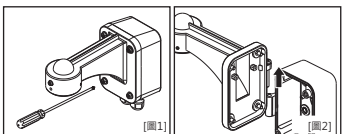

- 步驟2 將支架底座固定於牆壁
先將安裝孔位貼紙黏貼於牆上欲安裝之位置並鑽孔 (圖3)，再將支架底座對準孔位鎖入4顆螺絲固定於牆壁 (圖4)。如需使用支架底座中央圓孔，請於安裝前先使用工具將此圓孔敲下 (圖5)。
註：1. 壁掛螺絲長度建議 1.5英寸(38.1mm)以上
2. 螺絲非配件，請使用者自行處理。

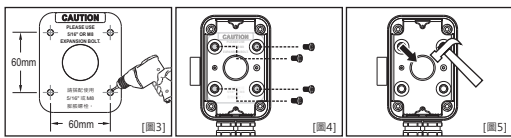

- 步驟3 將安全吊繩及控制線組穿過支架
先將安全吊繩及控制線組穿過支架 (圖6)，對準凹槽將快拆轉盤與支架結合並將支架螺絲鎖緊固定 (圖7)；再將支架由門栓處往下與支架底座結合 (圖8)。

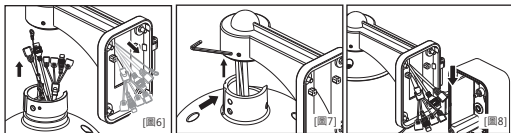

- 步驟4 固定安全吊繩並連接控制線組，完成球型攝影機安裝
先將攝影機安全吊繩鎖上支架底座 (圖9)，再依序將電源連接線、RJ-45網路連接線及控制線組連接完成 (圖10)。

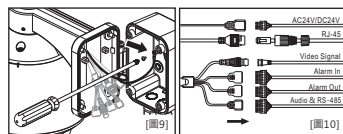

- 步驟5 完成球型攝影機安裝
將支架鎖回支架底座 (圖11)，完成球型攝影機安裝 (圖12)。注意：完成球型攝影機安裝後，請將支架上的安全螺絲鎖緊，避免掉落 (圖13)。



低溫啟動

在低溫環境中啟動攝影機時，因為內部溫度過低，可能導致攝影機動作異常。
因此，當攝影機由於停電或其它原因，需要在-40°C至-5°C的環境中啟動時，本機需執行低溫啟動程序。
低溫啟動步驟
開啟電源，等待加熱器工作1小時後，溫度檢知開關啟動，開啟系統電源，系統開始運作。

安裝前準備

在使用Full HD IP攝影機之前，請先確認攝影機RJ-45網路接頭和電源接頭是否接妥，並請網管人員提供一組未經使用的IP位址。出廠預設IP位址為192.168.0.200，使用者可以先行使用該IP位址去更改相關網路設定。

軟體需求

Full HD 網路攝影機需要軟體解壓縮器顯示影像，Full HD 網路攝影機的網頁介面需使用該軟體。當您第一次登錄本產品，Full HD 網路攝影機的網頁介面會自動安裝Universal ActiveX元件，請按下「安裝」鍵安裝該元件。

回復出廠預設值

- 使用硬體來回復出廠預設值，請按照下列步驟：
1. 按住「回復出廠預設值按鍵」10秒鐘。
 2. 約40秒鐘後網路連接LED燈將熄滅再點亮。
 3. 網路伺服器將重新開機。
 4. 使用IPScan軟體搜尋此IP設備。
 5. 使用網路瀏覽器開啟此IP設備。
 6. 輸入預設使用者名稱及密碼進行操作。
- 註1：出廠預設的使用者名稱和密碼為空白，由使用者自行設定輸入。
註2：為方便使用者起見，回復出廠預設值會回復到預設IP位址192.168.0.200。

使用HTML頁面來設定IP位址

- 請先在網路瀏覽器網址列，輸入預設IP位址192.168.0.200，並按照下列步驟執行，使用HTML頁面來更改IP位址：
1. 設定使用者名稱及密碼，登錄Full HD IP攝影機
 2. 按「組態設定」超連結
 3. 按「網路設定」、「一般設定」超連結
 4. 輸入或修改IP位址、子網路遮罩、網路閘道(Gateway)或HTTP連接埠
 5. 按「確認」鍵，完成上述修改

使用IPScan軟體工具來設定IP位址

- 您可以使用IPScan(網路設備搜尋軟體)工具來設定IP位址。要更改IP位址、子網路遮罩、網路閘道、或HTTP連接埠，請參照下列步驟：
1. 執行IPScan軟體工具
 2. 按「更新表單」鍵，區域網路內的所有設備將顯示在設備清單欄位
 3. 用滑鼠點選該設備
 4. 編輯或修改該設備之IP位址、子網路遮罩、網路閘道(Gateway)或HTTP連接埠等欄位
 5. 按「套用」鍵來更改該設定
 6. 按「更新表單」鍵來驗證該設定

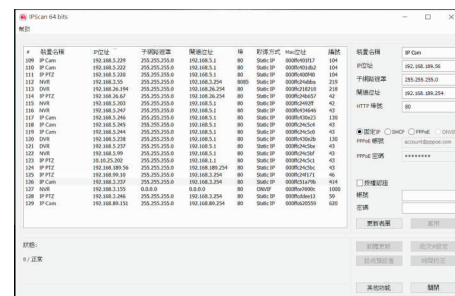

登入

出廠預設的使用者名稱和密碼為空白。欲登入Full HD 網路攝影機，請在登入頁面，設定使用者名稱及密碼並按下確認鍵，可同時完成使用者設定並登入。

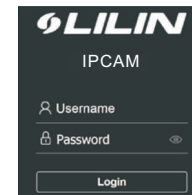

- 密碼強度要求：
1. 密碼長度需要8個字以上。
 2. 密碼必須包含英文大寫、小寫、數字及特殊符號。
 3. 密碼必須強制使用至少3種字型態