

### Part Description & Dimensions

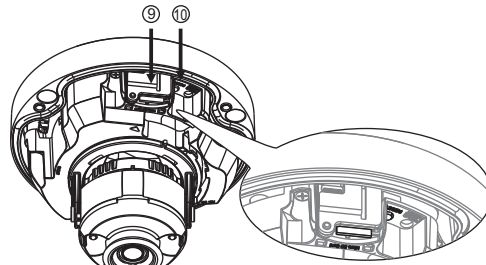

- ① Bottom bracket
- ② Upper cover
- ③ Transparent cover
- ④ Lens
- ⑤ RJ-45 Ethernet connector
- ⑥ Power jack (DC12V ±10%)
- ⑦ Audio in/out terminal
- ⑧ Alarm in/out terminal
- ⑨ Micro SD card slot
- ⑩ Factory default button

- Connect the RJ-45 Ethernet cable with a waterproof connector. First, remove the waterproof connector and unscrew the waterproof nut. Insert the Ethernet cable and connect to the RJ-45 connector with proper tools (FIG.5). Then, tighten the waterproof connector and nut before the RJ-45 connector is connected to the camera (FIG.6).

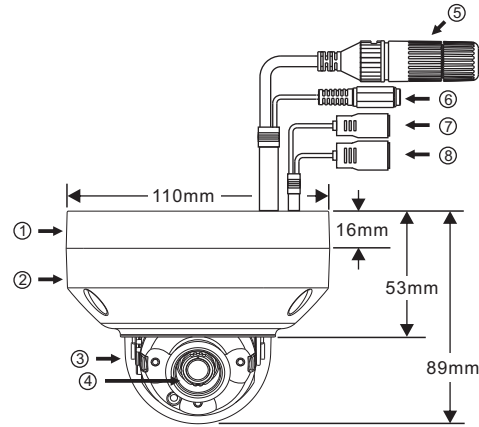
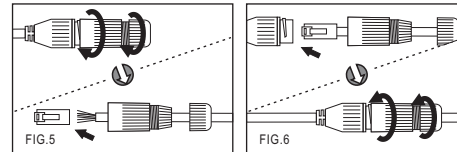

- 3. Adjust the pan, tilt, and azimuth of the camera to the desired location (FIG.7). Secure the upper cover to the bottom bracket with a hex key (FIG.8).

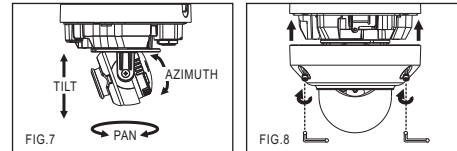

**!** During installation in a humid environment, leaving the transparent top cover open for an extended period of time may cause fogging.

- Do not remove the desiccant from its vacuum packaging for more than 5 minutes.
- Ensure that moisture does not come into contact with the desiccant.
- **【Angle adjustment → Desiccant → Transparent top cover】** The installation process should be completed within 10 minutes.

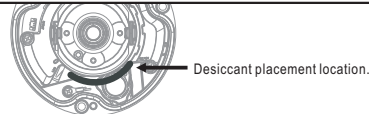

### Installation

1. Retrieve the camera and remove the bottom bracket from the upper cover with a hex key (FIG.1). Use the included screws (M4.0x25) through the holes marked as "a", and fix the camera in the desired location (FIG.2&3). Note: For outdoor installation, it is recommended to install a waterproof junction box.

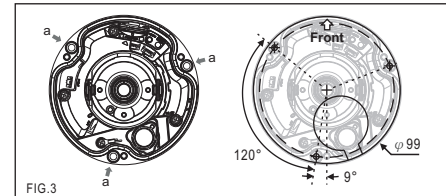
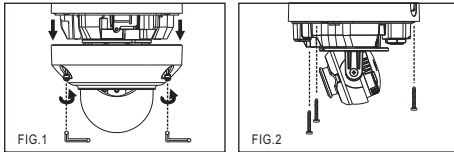

2. Attach the Ethernet and power cables to the RJ-45 connector and the DC-in connector, respectively (FIG.4).

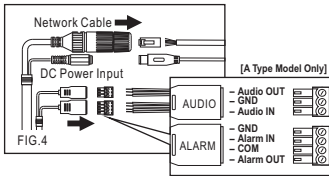

**Warning:** Do not throw your product in municipal waste. This product has been designed to enable proper reuse of parts and recycling. The symbol of the crossed out wheeled bin indicates that the product (electrical and electronic equipment) should not be placed in municipal waste. Check local regulation for disposal of electronics products.



### System Architectures

For connecting IP Camera series to the network, please follow one of the system architectures:

- (1). Use DC12V power adaptor and network switch connected to a network.

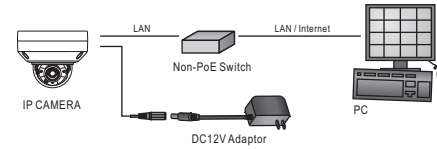

- (2). Use with PoE of the network switch connected to the network.

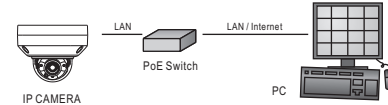

- (3). Use PoE power injector and the network switch connected to the network.

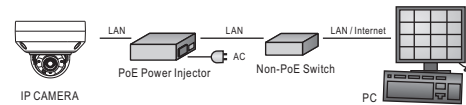

### Before Accessing IP Cameras

Before accessing the IP camera, make sure that the camera's RJ-45 network, audio, and power cables are properly connected. To set the IP address, consult your network administrator for an available IP address. The default IP address for each IP camera is 192.168.0.200. Users can use the default IP address for verifying the camera's network connection.

### Emergency Factory Default

- To restore the hardware to factory default settings, please follow these steps:
1. Press and hold "RESET Key" for 10 seconds and release.
  2. Wait for about 40 seconds, and the network LED light should turn off, and go back on again.
  3. The camera is now restored to factory default settings, and will reboot automatically.
  4. Search for the IP device using the IPScan software.
  5. Start the IP device via an Internet browser.
  6. Enter the username and password to operate.

**NOTE1:** The factory default username and password are empty, and the user can set an account for login.  
**NOTE2:** The IP address will revert to the default setting of 192.168.0.200.

### Configuring IP Addresses via Web Interface

To change an IP address via web interface, type the default IP address (192.168.0.200) in the Internet browser and follow the steps below:

1. Login to the Full HD IP camera with the set username and password.
2. Click **Basic Mode** configuration hyperlink.
3. Click **Network->General** hyperlink.
4. Change the IP address, subnet mask, gateway, or HTTP port for the IP camera.
5. Click **Submit** to verify the settings.

**Note:** This equipment has been tested and found to comply with the limits for a Class B digital device, pursuant to part 15 of the FCC Rules. These limits are designed to provide reasonable protection against harmful interference in a residential installation. This equipment generates, uses and can radiate radio frequency energy and, if not installed and used in accordance with the instructions, may cause harmful interference to radio communications. However, there is no guarantee that interference will not occur in a particular installation. If this equipment does cause harmful interference to radio or television reception, which can be determined by turning the equipment off and on, the user is encouraged to try to correct the interference by one or more of the following measures:

- Reorient or relocate the receiving antenna.
- Increase the separation between the equipment and receiver.
- Connect the equipment into an outlet on a circuit different from that to which the receiver is connected.
- Consult the dealer or an experienced radio/TV technician for help.

### Software Requirements

Universal ActiveX software components are required for web interface display of JPEG or Full HD video. When you login to the IP camera by Internet Explorer, the security warning dialog box will prompt the installation of the Universal ActiveX. Click **Install** to download it.

### Configuring IP Addresses with IPScan Software

To change the settings of the IP address, subnet mask, gateway, or HTTP port, you can follow the steps below:

1. Run the IPScan software.
2. Click **Refresh**. All available devices should be listed in the device list.
3. Select your device from the list provided.
4. Change the IP address, subnet mask, gateway, or HTTP port for the IP camera.
5. Click **Apply** to submit the settings.
6. Click **Refresh** to verify the settings.

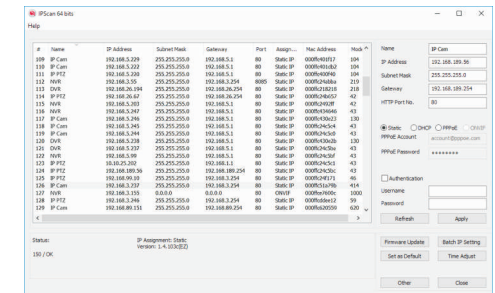

### Login

The factory default username and password are empty. To login to the Full HD IP camera, please set the username and password on the login page. Press [Login] to complete the setting and login simultaneously.

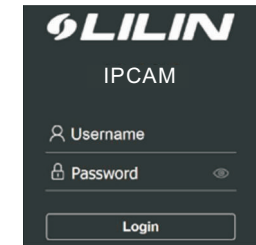

Password have to meet the following criteria:

1. More than or equal to 8 characters.
2. Allow uppercase letter, lowercase letter, number digit, and special character.
3. Must have at least three types of character sets.



警告: 此圖示, 指在廢棄產品時不可直接丟棄垃圾桶, 應進行拆解, 並分類進行回收再利用。

## 安裝說明

### 部件說明及尺寸

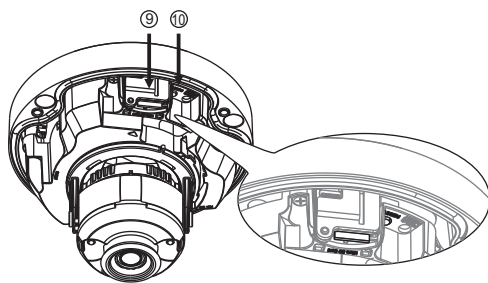
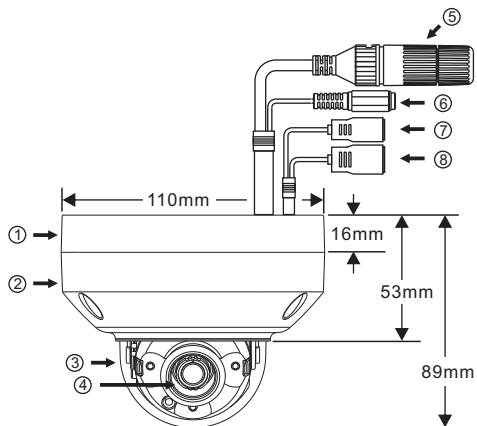

- ① 底座
- ② 上蓋
- ③ 透明罩
- ④ 鏡頭
- ⑤ RJ-45網路接頭 (支援PoE供電)
- ⑥ 電源輸入接頭 (DC12V ±10%)
- ⑦ 聲音輸入/輸出端子
- ⑧ 警報輸入/輸出端子
- ⑨ Micro SD卡插槽
- ⑩ 回復工廠預設值按鍵

## 安裝

- 首先取出網路攝影機, 使用六角板手將底座與上蓋分開 (圖1)。再取出所附的螺絲 (M4.0x25), 經由標示為 "a" 的螺絲孔, 將攝影機底座固定在所需的位置上 (圖2&3)。

註: 戶外建議加裝接線盒!

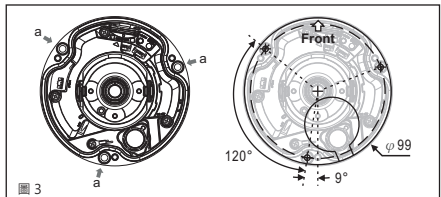
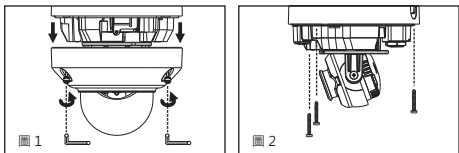

- 將網路線及電源線分別接上網路攝影機的RJ-45網路接頭與DC電源輸入接頭 (圖4)。

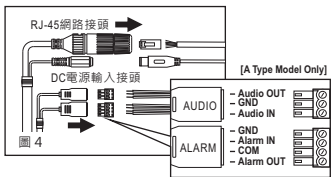

- 搭配防水接頭連接RJ-45網路線

首先將防水接頭取下, 並將防水螺帽旋開; 穿過網路線後再使用工具連接RJ-45接頭 (圖5)。將RJ-45接頭連接至網路攝影機, 再依序將防水接頭、防水螺帽旋緊 (圖6)。

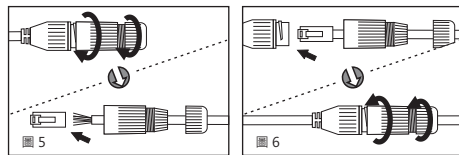

- 調整攝影機鏡頭所需的水平、垂直、傾斜攝影角度到所需監看的位置 (圖7)。再使用六角板手將上蓋鎖回底座固定 (圖8)。

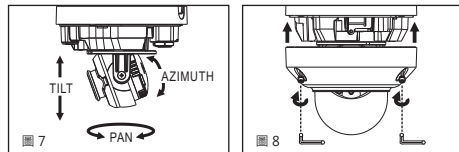

- 在潮濕環境施工期間, 長時間打開透明上蓋可能會導致起霧。
- 請勿將乾燥劑從真空包裝中取出超過5分鐘。
- 注意不要讓水分接觸到乾燥劑。
- 【角度調整→乾燥劑→透明上蓋】安裝的過程請在10分鐘內完成。

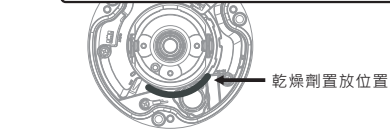

## 系統架構

請依據下列其中一種系統架構, 連結高畫質網路攝影機和您的網路。

- 使用DC12V電源變壓器和網路交換器連接網路。

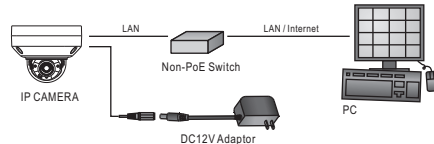

- 使用配備 PoE 的網路交換器連接網路。

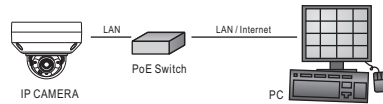

- 使用 PoE 供電裝置 (Power Injector) 和網路交換器連接網路。

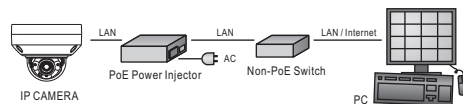

## 安裝前準備

在使用 Full HD IP攝影機之前, 請先確認攝影機RJ-45網路接頭和電源接頭是否接受, 並請網管人員提供一組未經使用的IP位址。出廠預設IP位址為192.168.0.200, 使用者可以先行使用該IP位址去更改相關網路設定。

## 回復出廠預設值

使用硬體來回復出廠預設值, 請按照下列步驟:

- 按住「回復出廠預設值按鍵」10秒鐘。
- 約40秒鐘後網路連接LED燈將熄滅再點亮。
- 網路伺服器將重新開機。
- 使用IPScan軟體搜尋此IP設備。
- 使用網路瀏覽器開啟此IP設備。
- 輸入預設使用者名稱及密碼進行操作。

- 註1: 出廠預設的使用者名稱和密碼為空白, 由使用者自行設定輸入。
- 註2: 為方便使用者起見, 回復出廠預設值會回復到預設IP位址192.168.0.200。

## 軟體需求

Full HD 網路攝影機需要軟體解壓縮器顯示影像, Full HD 網路攝影機的網頁介面需使用該軟體。當您第一次登錄本產品, Full HD 網路攝影機的網頁介面會自動安裝Universal ActiveX元件, 請按下「安裝」鍵安裝該元件。

## 使用HTML頁面來設定IP位址

請先在網路瀏覽器網址列, 輸入預設IP位址192.168.0.200, 並按照下列步驟執行, 使用HTML頁面來更改IP位址:

- 設定使用者名稱及密碼, 登錄 Full HD IP攝影機
- 按「組態設定」超連結
- 按「網路設定」「一般設定」超連結
- 輸入或修改IP位址、子網路遮罩、網路閘道(Gateway)或HTTP連接埠
- 按「確認」鍵, 完成上述修改

## 使用IPScan軟體工具來設定IP位址

您可以使用IPScan(網路設備搜尋軟體)工具來設定IP位址。要更改IP位址、子網路遮罩、網路閘道、或HTTP連接埠, 請參照下列步驟:

- 執行IPScan軟體工具
- 按「更新表單」鍵, 區域網路內的所有設備將顯示在設備清單欄位
- 用滑鼠點選該設備
- 編輯或修改該設備之IP位址、子網路遮罩、網路閘道(Gateway)或HTTP連接埠等欄位
- 按「套用」鍵來更改該設定
- 按「更新表單」鍵來驗證該設定

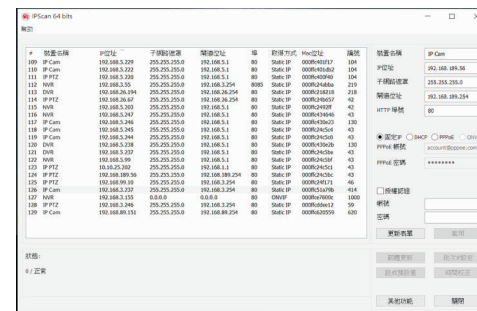

## 登入

出廠預設的使用者名稱和密碼為空白。欲登入Full HD網路攝影機, 請在登入頁面, 設定使用者名稱及密碼並按下確認鍵, 可同時完成使用者設定並登入。

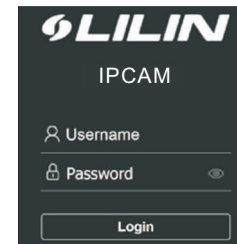

密碼強度要求:

- 密碼長度需要8個字以上。
- 密碼必須包含英文字大寫、小寫、數字及特殊符號。
- 密碼必須強制使用至少3種文字型態。