

# Quick Installation Guide

Ver. 2.0

## Accessories

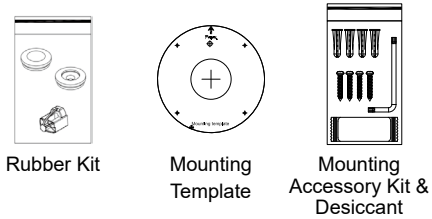

Rubber Kit

Mounting Template

Mounting Accessory Kit & Desiccant

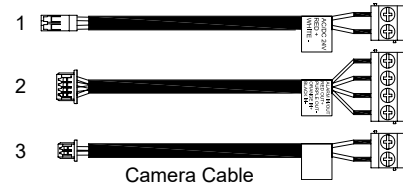

Camera Cable

1	Power
2	Alarm
3	Audio (2 cables)

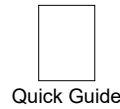

Quick Guide

**Note:** Please refer to user manual for recommended alarm connection.

## Dimensions

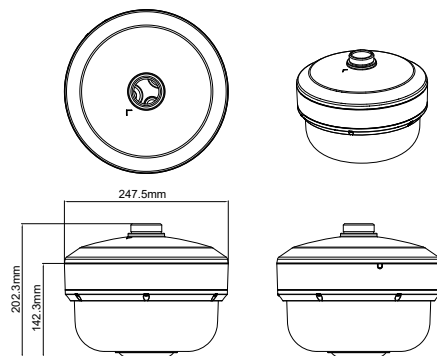

## Hardware Installation (Wall Mount Bracket Assembly)

1. Loosen the 6 anti-drop screws on the top cover and open it.

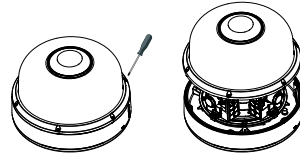

2. Remove and discard the protective EPE from the lens modules.

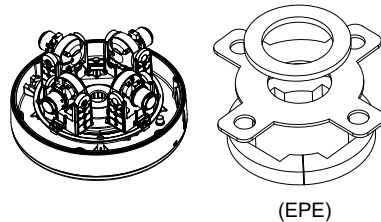

3. Add a desiccant to the recommended position as below.

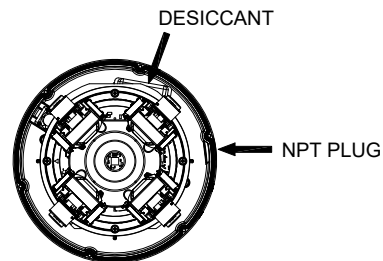

4. Plug the spring cable back to the top cover. Then lock the 6 anti-drop screws on the top cover.

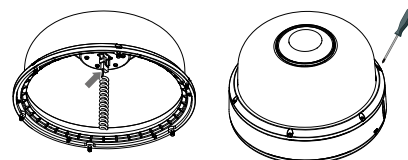

5. Loosen the anti-drop screw on the lateral side of the bottom cover.

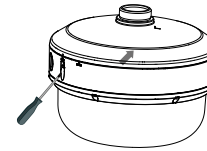

6. Rotate the cap (▽) from LOCK to OPEN in order to remove the cap.

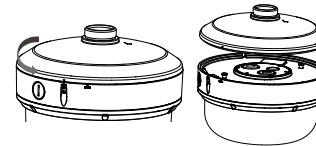

7. Loosen the 3 anti-drop screws on the bottom plate and open it.

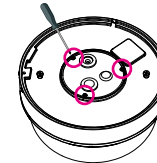

8. Prepare the network cable and wire it through the grommet on the bottom plate.

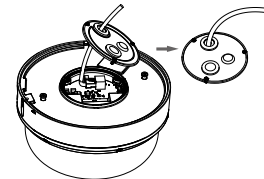

9. Place the bottom plate back to the camera and lock the 3 anti-drop screws to secure it.

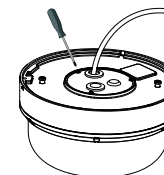

## Hardware Installation [Wall Mount]

1. Align the bottom cap to the bracket handle and rotate it until it is fixed on the wall mount bracket.

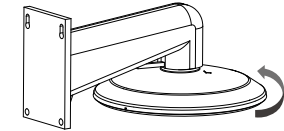

2. Fasten the safety wire on the hook.

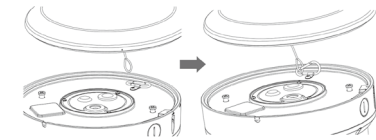

3. Rotate the camera from OPEN to LOCK in order to fix the camera. The ▽ mark should be aligned with the LOCK (□) mark.

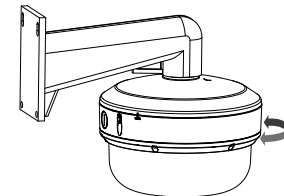

4. Lock the anti-drop screw on the lateral side of the bottom cover to fix the camera.

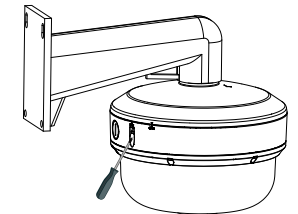

# Quick Installation Guide

Ver. 2.0

## Hardware Installation [Pendant Mount]

1. Rotate the screw with the appropriate tool on the base of the pendant mount to lock it in place.

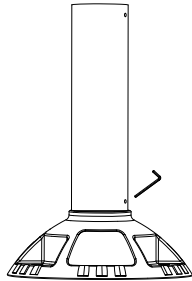

2. Choose a desired installation location and use a driller to drill 3 holes on the surface for securing the pendant mount. Insert 3 screw anchors into the holes and secure the pendant mount to the surface using the screws for the anchors.

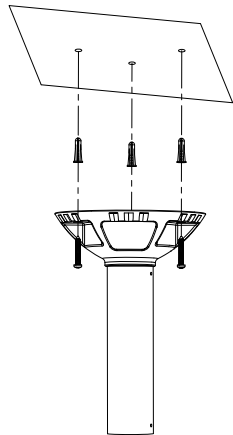

3. Fasten the safety wire on the hook.

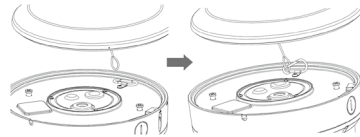

4. Wire the pigtail cable inside the pendant mount bracket. Align the bottom cap of the camera to the bracket handle and rotate it until it is fixed on the pendant mount bracket. Then secure the camera in place with the screw using the appropriate tool.

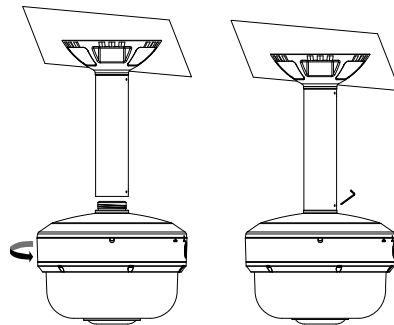

## Hardware Installation [Ceiling Mount]

1. Place the positioning label at the desired installation location on the ceiling and use a driller to drill the marker ⊕ symbol in order to allow the screw on the camera to pass through the drilled hole.

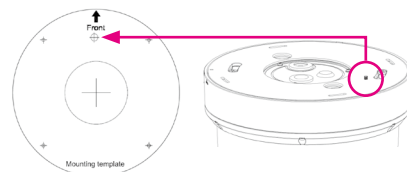

2. Loosen the 4 screws on the plate.

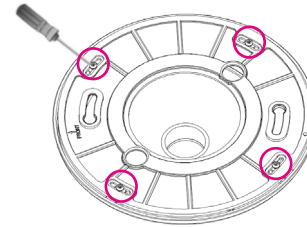

3. Use a driller to drill 4 holes on the surface where the positioning label is placed. Insert 4 screw anchors into the holes and secure the plate to the ceiling using the screws for the anchors.

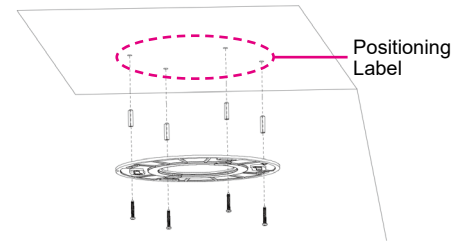

4. Put the camera on the plate.

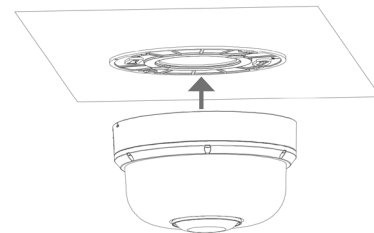

5. Fasten the safety wire on the hook.

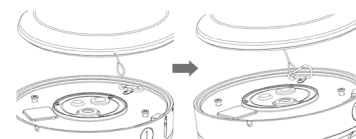

6. Please note that the OPEN ■ mark should be aligned with the screw hole on the plate. (There is only 1 screw hole on the plate for easy recognition.)

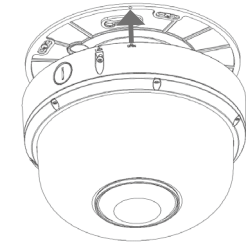

7. Twist the camera counterclockwise until it is secured firmly in place. Then fix the camera on the ceiling with the screw.

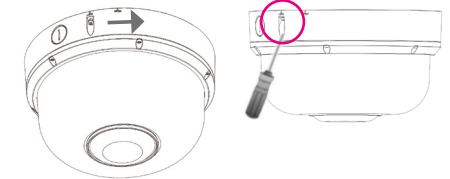

## Web Browser

1. Find and open a browser on your computer.
2. Type 192.168.0.200 (the camera's default IP address) in the address bar, then press Enter.
3. You will be prompted with a pop-up window asking for login information.