



Navigator 5.0 User Manual

Table of Contents

Overview	5
Navigator Main Features	5
Copyrights	6
Before Using Navigator	6
User Manual	7
Uninstall Navigator	7
Acronym	7
How to Login Navigator	7
User Account Bookmark	8
Chapter 1 User Manager	8
Chapter 1.1 Add a User	9
Chapter 1.2 Modify an Existing User	9
Chapter 1.3 Delete a User	10
Chapter 1.4 User Authorization	10
Chapter 1.5 Operation Access Management	10
Chapter 2 System Settings	13
Chapter 3 Programming Tool	14
Chapter 3.1 GPU Graphics Decode Setting	15
Chapter 3.2 Memory Protection and Watchdog Setting	16
Chapter 4 Navigator Login	17
Chapter 4.1 How to Add a Device to Navigator	17
Chapter 4.1.1 Add a New Device	18
Chapter 4.2 Set up Hard Disk Recording	19
Chapter 4.3 Device Type	19
Chapter 4.3.1 NAV IPCAM HTTPS Connection Method	20
Chapter 4.4 ONVIF Settings	21
Chapter 4.4.1 NVR/DVR P2P Connection	21
Chapter 4.5 Find Device	22
Chapter 4.5.1 How to Change Device Names in IPSCAN	22
Chapter 4.5.2 Change the Device IP/HTTP/HTTPS Port Number in IPSCAN	23
Chapter 4.5.3 Update Device Firmware in IPSCAN	23
Chapter 4.5.4 Batch IP Setting in IPSCAN	24
Chapter 4.5.5 Restore a Device to its Default Settings in IPSCAN	24
Chapter 4.5.6 Enable or Disable the SDDP Function in IPSCAN	25
Chapter 4.6 Alarm Input Management	25
Chapter 4.6.1 Remote IP camera with digital I/O	26
Chapter 4.7 Alarm Output Management	26
Chapter 4.7.1 Advanced Alarm DO	27
Chapter 5 MOXA-ioLogik-E1212Control Box	27
Chapter 5.1 MOXA General Settings	28
Chapter 5.2 MOXA Ethernet Configuration	28
Chapter 5.3 MOXA Web Console IO Setting	28
Chapter 6 IP Camera IE Webpage IVS Tripwire Detection	28
Chapter 6.1 Navigator Alarm Management Settings	29
Chapter 6.2 External IO device	30
Chapter 6.3 Alarm Acknowledgment	30
Chapter 6.4 Notify Navigator Installed on Other Computers	31
Chapter 7 Recording Settings	31
Chapter 7.1 Schedule Recording Settings	31
Chapter 7.2 Motion Detection Recording	32
Chapter 7.3 Recording at System Startup	33
Chapter 7.4 Estimated Recording Days	33

Chapter 7.5 Network Storage NAS	34
Chapter 8 Group Settings	34
Chapter 8.1 Grouping	34
Chapter 8.2 Group Naming	35
Chapter 8.3 Auto add Devices in a Group	35
Chapter 8.4 Quickly Add device	36
Chapter 8.4.1 Add an NVR or NAV Host	37
Chapter 8.5 Group Authentication	37
Chapter 8.6 User Authentication	38
Chapter 8.7 View a Group	38
Chapter 8.8 Group Sequential Playback	38
Chapter 8.9 Main Grouping	38
Chapter 8.10 Split View	39
Chapter 8.11 Dynamic Video Channel Swapping	39
Chapter 8.12 Digital Zoom	39
Chapter 9 Playback in Navigator	40
Chapter 9.1 Playback	40
Chapter 9.2 Playback for an IP Camera Within the MainGrouping	40
Chapter 9.3 Multi-Channel Playback	41
Chapter 9.4 Remote Multi-Channel Playback	41
Chapter 9.5 Remote DVR/NVR Playback	42
Chapter 9.6 SmartSearch	43
Chapter 9.7 AVI File Export & Play from a File	43
Chapter 9.7.1 Export AVI with OSD	43
Chapter 9.7.2 Export AVI without OSD	43
Chapter 9.8 Multi-Channel Backup	44
Chapter 9.9 Snapshot	44
Chapter 9.10 Alarm Event Playback	44
Chapter 9.11 Tagging	45
Chapter 10 Audio	45
Chapter 10.1 Two-way Audio	45
Chapter 10.2 Two-way Audio Auto Switching	45
Chapter 10.3 Audio Recording	45
Chapter 11 Archive Manager	45
Chapter 11.1 Archive Source	45
Chapter 11.2 Archive Destination	46
Chapter 11.3 Synchronization	46
Chapter 11.4 Back up Log	47
Chapter 12 PTZ Control Panel	47
Chapter 12.1 Preset Point Settings	47
Chapter 12.1.1 PTZ Control Panel Instructions	48
Chapter 12.2 On-screen PTZ Control	48
Chapter 12.2.1 Control PTZ via a Mouse	49
Chapter 12.3 On-screen Panoramic Camera Control	49
Chapter 12.3.1 Fisheye Control Panel Instructions (Ceiling Mount, Table Mount)	50
Chapter 12.3.2 Wall Mount Installation	50
Chapter 12.4 Navigator Status Panel	51
Chapter 12.5 Control PTZ via our 3D Keyboard	51
Chapter 12.6 Split View	52
Chapter 12.7 Control a Camera	52
Chapter 12.8 IP Camera ePTZ or ROI Feature	52
Chapter 12.9 Switch between Navigator and Virtual MatrixMonitors	52
Chapter 12.10 Keyboard Playback	52
Chapter 13 eMap Manager	53
Chapter 13.1 Access eMap	53
Chapter 13.2 Find Devices	53
Chapter 13.3 PTZ Control Panel	53
Chapter 13.4 Toolbar	54

Chapter 13.5 eMap Alarm Options	54
Chapter 13.6 Add a Map	55
Chapter 13.7 Add a Device to the Map	55
Chapter 13.8 Delete a Device from the Map	55
Chapter 13.9 Modify a Device	55
Chapter 13.10 Find a Device	56
Chapter 13.11 Alarm on eMap	56
Chapter 13.12 Quick Map Reference	56
Chapter 13.13 Alarm Control Mode & Switching Mode	56
Chapter 14 Web Server	57
Chapter 14.1 8021 OCX Web Page Browsing Connection Mode	58
Chapter 14.2 Edge Enables IE Compatibility Mode	58
Chapter 14.3 NAT Port Setting	59
Chapter 14.4 Apply for a DDNS Account	59
Chapter 15 Database Manager	59
Chapter 15.1 AI Export to IVS Simple Chart	61
Chapter 16 Multiple Monitors	61
Chapter 16.1 Navigator Multi-Screen Matrix Output	61
Chapter 16.2 Alarm Acknowledgement	62
Chapter 16.3 Notify Navigator on Another Computer	63
Chapter 16.4 Navigator Software 2x2 Video Wall	63
Chapter 17 Retail and Distribution Business Solutions	63
Chapter 17.1 Retail POS Application	64
Chapter 17.2 POS Connection via TCP/IP for Retail Business	64
Chapter 17.3 POS system and Navigator Connection Test	64
Chapter 17.4 Link POS to a Camera Channel	65
Chapter 17.4.1 POS Replace Setting	66
Chapter 17.5 POS Transaction Playback	66
Chapter 17.6 Search POS Transactions	66
Chapter 17.7 Scanner Connection for Logistic Business	66
Chapter 18 Mobile Device Support	66
Chapter 19 Navigator Software Streaming Client & Server	67
Chapter 19.1 Navigator Streaming Server	67
Chapter 19.2 Navigator Software Streaming Client	68
Chapter 19.2.1 Navigator Firewall Mode Setting	68
Chapter 19.2.2 Navigator Navigator Service Settings	68
Chapter 19.2.3 Navigator Screen Capture Streaming Setting	70
Chapter 19.2.4 Navigator Setup Receiver	70
Chapter 19.3 How to set Mosaic TV Wall	70
Chapter 19.4 Auto set TV viewer setting	71
Chapter 19.5 Easy Mode	71
Chapter 19.6 Easy Mode Advanced Function	72
Chapter 20 Automatic Number Plate Recognition (ANPR)	72
Chapter 20.1 Before Using This AI Engine	72
Chapter 20.2 Caution	72
Chapter 20.3 Windows Version 10 Cycle Data Table	72
Chapter 20.4 Windows Version Corresponding Graphics Card Series	73
Chapter 20.5 Install CUDA driver	73
Chapter 20.6 CUDA Version Compatible with Graphics Card Series	74
Chapter 20.7 OpenVINO™ Compatible with GPU Model Series	74
Chapter 20.8 AI Engine Compatible Graphics Card Series	74
Chapter 20.9 AI Engine Back-end License Plate Recognition Settings	75
Chapter 20.10 Navigator Software Setting for AI Number Plate Recognition	75
Chapter 20.11 License Plate Character Height Adjustment	76
Chapter 20.12 ANPR System List Setting	76
Chapter 20.13 License Plate Import/Export List	76
Chapter 20.14 The Settings of AI Traffic Management	77
Chapter 20.15 Traffic Zones	77

Chapter 20.16 Prohibit Zone Detection (Parking Violation)	77
Chapter 20.17 Queuing Detection	78
Chapter 20.18 Human Mask Detection Setting	79
Chapter 20.19 Social Distancing	81
Chapter 20.20 Setup Social Distancing	81
Chapter 20.21 People Density of AI Software	82
Chapter 20.22 Setting the Front-end Camera AI Function in Navigator	83
Chapter 20.23 AI Alarm and Behavior Detection Setting	83
Chapter 20.24 Setting of Front-end Camera Counter on the Webpage	84
Chapter 20.25 Setting to Synchronize Front-end Camera Counter in the Navigate	84
Chapter 21 Face Recognition (Premium Authorization)	85
Chapter 21.1 System Configuration	85
Chapter 21.2 Configure Detection Area & Facial Recognition	86
Chapter 21.3 Facial Recognition and Alarm Output	87
Chapter 21.4 Set Alarm Output Settings for Applications	88
Chapter 21.5 Schedule of Facial Recognition Triggering a Digital Output	88
Chapter 21.6 Add Faces Photo into Database	89
Chapter 21.7 Add Photos Database for a Face	89
Chapter 21.8 Adding Photos into Database	90
Chapter 21.9 Historical Recognized Data	91
Chapter 21.10 Historical Guest Face Tracking Search Mode	92
Chapter 21.11 Search the Name for the Video	92
Chapter 21.12 Playback	93
Chapter 21.13 Advance Facial Recognition Setting	93
Chapter 21.14 Installations	93
Chapter 21.15 Confidence Rate and Pixel of a Photo	94
Chapter 21.16 Two Phases of Quick Face Photos Setup	95
Chapter 21.17 Camera Setting Requirements:	96
Chapter 21.18 Face Recognition Datasheet	96
Chapter 22 Failover	97
Chapter 22.1 Channel Hot Spare Mode	97
Chapter 22.2 Host Hot Spare Mode	99
Chapter 22.3 Enable Failover Monitoring Service	99
Chapter 22.4 Failover Client Setting	99
Chapter 22.4.1 Channel Hot Spare Mode	100
Chapter 22.5 Fault -Tolerant Migration Service Host Setting	100
Chapter 23 Troubleshooting and Support	103
Chapter 23.1 Choosing between SMR and CMR in Hard Drives	103
Chapter 23.2 Computer Room Guidelines	104
Chapter 23.3 5.0 System Requirement	104
Chapter 23.4 Other Peripheral Hardware Support Table	106
Chapter 23.5 Automatically Login In Windows 10& 11	107
Chapter 24 System Optimization	112
Chapter 24.1 Windows Change User Account Control Settings	112
Chapter 24.2 Turn off Hard Drive Defragment	113
Chapter 24.3 Turn off creating file content index	114
Chapter 24.4 Turn off Power Saving Mode	115
Chapter 24.5 NVIDIA Graphics Card Maximum Performance	115
Chapter 24.6 NVIDIA GeForce Experience	116
Chapter 24.7 Set up Windows Manual Update	116
Chapter 24.8 Windows 10 Manually Update Setting	117
Chapter 24.9 Windows 7/10/11 Update Information	117
Chapter 25 Windows Update Optimization Function	117
Chapter 25.1 Close Server Windows	117
Chapter 25.2 Restore Server Windows	120

Overview

The Navigator (hereafter referred to as “Navigator”) is a comprehensive solution to the management of our network products, including IP cameras, DVRs/NVRs, and a wide range of applications. Navigator consists of (1) network video recording software, (2) eMap Manager, (3) Database Manager, (4) Web Server, and (5) Remote DVR/NVR playback and file download.

Major functions of this software include the management of videos and images recorded by a wide range of cameras produced by us, recording video clips in the SD card of remote IP cameras and DVRs/NVRs, and supporting video playback and file download. Navigator can be installed at various sites for camera management. According to geographical locations and functionalities, the software can also divide IP cameras and DVRs/NVRs into groups to help users view group images and videos.

eMap Manager is an innovative central management system for live monitoring, alarm snapshots, and map management. Devices installed at different locations can be displayed and managed with simple clicks on user-defined maps. One of the many highlights of this function is the dual screen design, which ease the management of DVRs/NVRs and IP cameras.

Navigator is designed for hybrid installment of IP camera, video server, IP Fast Dome, and DVRs. Its diverse functions provide the necessary flexibility in managing record storage devices and deliver a comprehensive solution to digital surveillance. Major features of Navigator are listed as followed.

Navigator Main Features

- Record and manage videos from IP H.264/H265/MJPEG cameras and DVRs/NVRs
- Support up to 108 recording channels.
- Support scheduled, continuous, and motion detection recording
- Support two-way audio and audio recording.
- Integrated alarm output management
- eMap live video with alarm snapshots
- iPhone and Android devices support
- IP Fast Dome control and PTZ control
- Digital zoom, ePTZ, and region of interest (ROI) support
- Support video file conversion to AVI/MP4 format
- Easy-to-use calendar and time selections for video playback
- NAV matrix multi-screen and 2x2 split screen
- User Manager for login, device group, and view group permission management.
- Support P2P NVR remote connection.

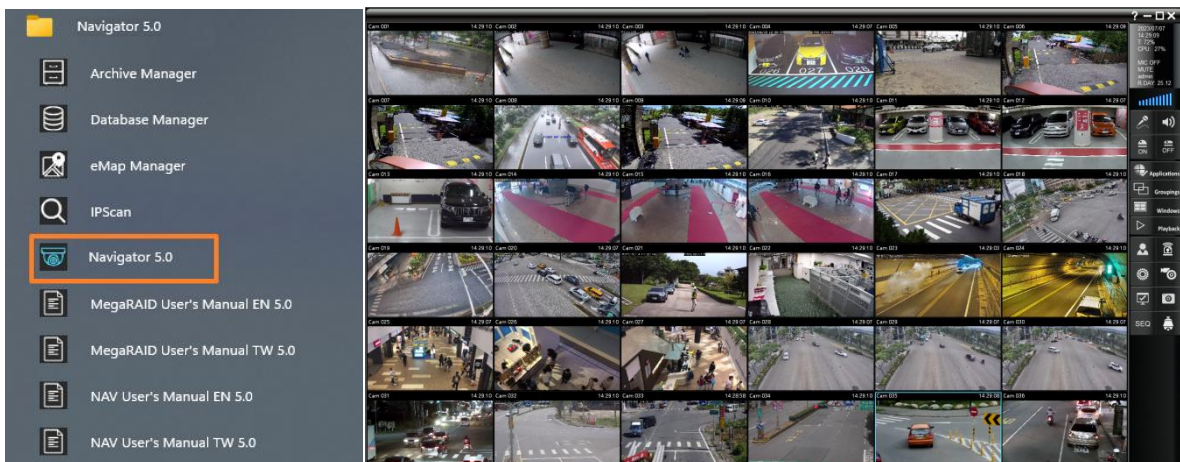

Copyrights

We hold the exclusive ownership of the software and all intellectual property rights embodied therein, including copyrights and valuable trade secrets incorporated in the software's design and coding methodology. The software is protected by international treaty. This agreement provides you with only a limited use license, and does not grant you any intellectual property rights in the software. Adobe and Acrobat Reader are either registered trademarks or trademarks of Adobe Systems Incorporated in the United States and/or other countries. Windows, Windows 2000, Windows XP, Windows Vista, and Windows 7 are registered trademark of Microsoft Corporation in the United States and other countries.

Before Using Navigator

The Navigator is a video recording application. Although Navigator supports multiple hard drives recording, when the overwrite setting is enabled, the oldest recorded video clips will be deleted first if the designated storage is full. Should you want logical partitions in your hard disk drive, allocate at least 60 GB (10% reserved space) for each drive.

To change the hard drive setting, click System Settings . Select the hard drive(s) to which you want Navigator to save the recorded videos. It is recommended not to choose the system disk as the destination drive.

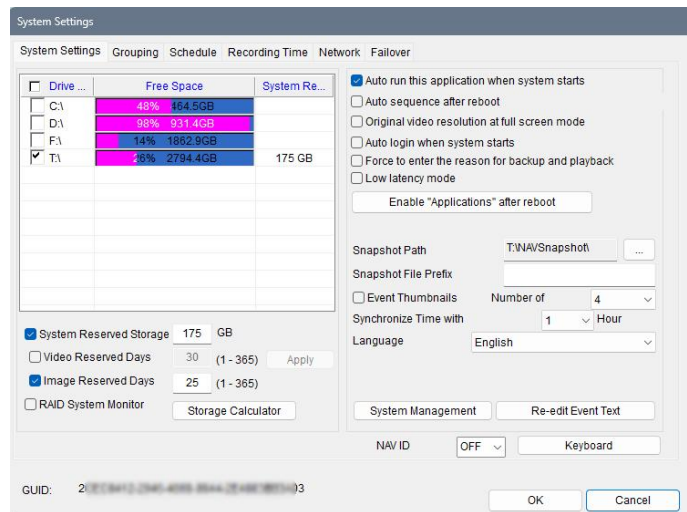

Furthermore, each logical HDD drive should contain at least **10%** empty space for storing video data. Navigator deletes the oldest files first until it reaches 90% of the logical drive, and it proceeds to the next logical hard disk drive for recording. It is recommended not to use external hard drives and to opt for hard drives with a capacity of 500GB or more. Using smaller capacity drives might lead to insufficient space for overwrite recording, which could affect the recording speed. Please select hard drives with a 7200rpm rotational speed, as this will be beneficial for writing speed.

Some brands of server hosts may not have a physical graphics card, or the environment does not allow the connection of a physical monitor. In such cases, as long as your device has HDMI output, you can install an EDID emulator. This device can simulate the physical monitor Direct3D, and the real-time video will be displayed normally.

- It is necessary to connect a physical monitor or install a virtual EDID emulator, otherwise Direct3D will not work normally, resulting in black screens in real-time and playback videos.
- Please do not connect Virtual EDID emulator and external output simultaneously.
- When using a virtual monitor, the built-in or external graphics card must support Direct3D for the EDID emulator to function.





User Manual

This Navigator user manual is in the PDF format. To access the manual, go to Start→All Programs→Navigator→User Manual. You must install Acrobat Reader or use Google Chrome for opening the manual.

Uninstall Navigator

To uninstall Navigator, select Start→All Programs→Navigator→Uninstall Navigator. Before you continue, be sure to back up your database, and you can import the database to the new installation. Please see Database Manager in this document for details.

Acronym

- NCC: Navigator Control Center
- VM: View Manager
- NAV: Navigator Corporate
- PTZ: Pan, tilt, and zoom camera
- DVR: Digital video recorder
- NVR: Network video recorder
- HDD: Hard disk drive
- FPS: Frame rate per second
- OSD: On-screen display
- ANPR: PC based number plate recognition system
- LPR: Edge license plate recognition camera

How to Login Navigator

To log into Navigator, open it from the desktop or execute Navigator through the Start menu. For information security considerations, the first time you log in, a warning window will appear, reminding you to use a password that meets the required strength to ensure the security of your system. (Please refer to Chapter 1 for creating user accounts and passwords).



Note:For system default account, enter "admin" and empty as username and password to login.

When logging into the system, a user login dialog box will pop up. Please select "Normal Mode". For advanced usage, there are other login system modes available, such as LDAP and Active Directory (AD) modes.

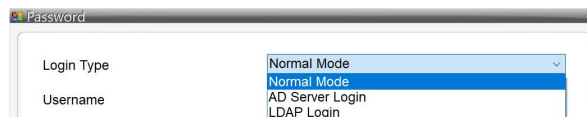

User Account Bookmark

Before logging into the system, there is a user account bookmark feature available for easy and quick access to switch between accounts. It supports multiple account memory locations and up to 128 groups can be set.

The username and password need to be created in advance by the admin user administrator. (Please see Chapter 1).

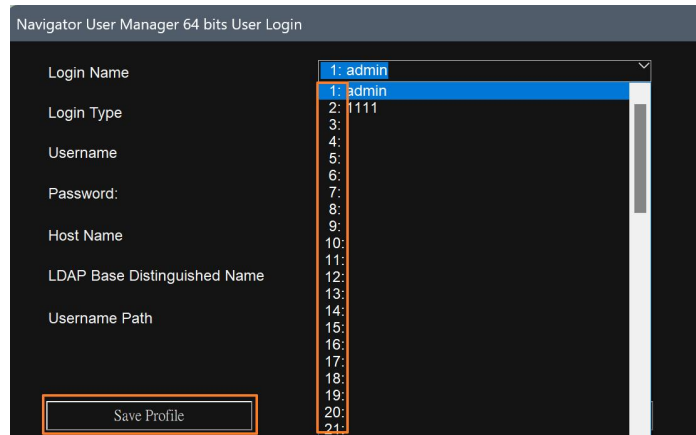

Chapter 1 User Manager

The admin user account has the administrator authority, and can manage various permissions including camera monitoring, playback, setting and other account permissions.

When logging in as the user administrator for the first time, a security warning will pop up, prompting you to create a new password.

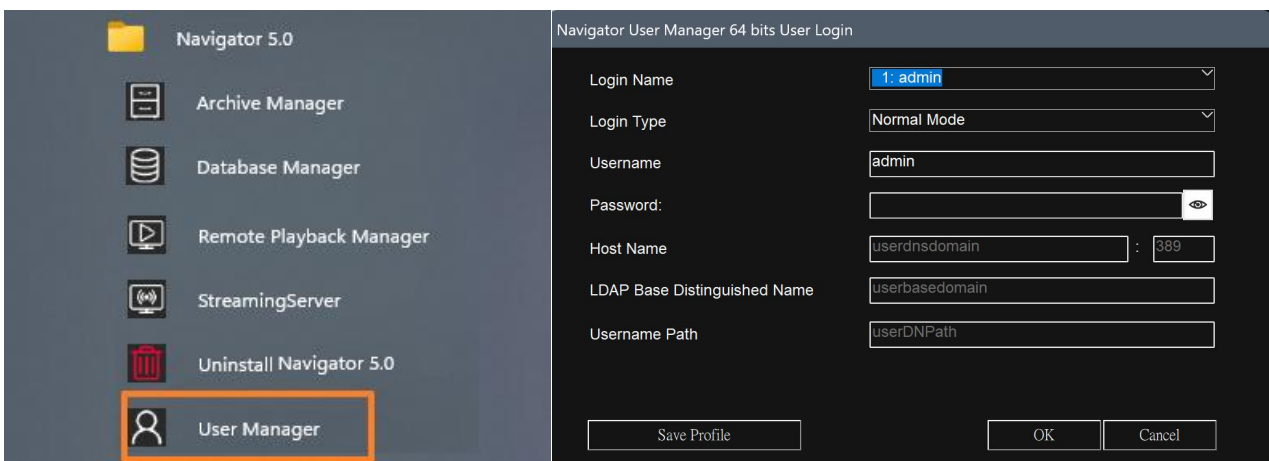

For the highest user administrator group, the default account is "admin" and the password is empty.
To strengthen the password security, the following four conditions must be met when creating a password:

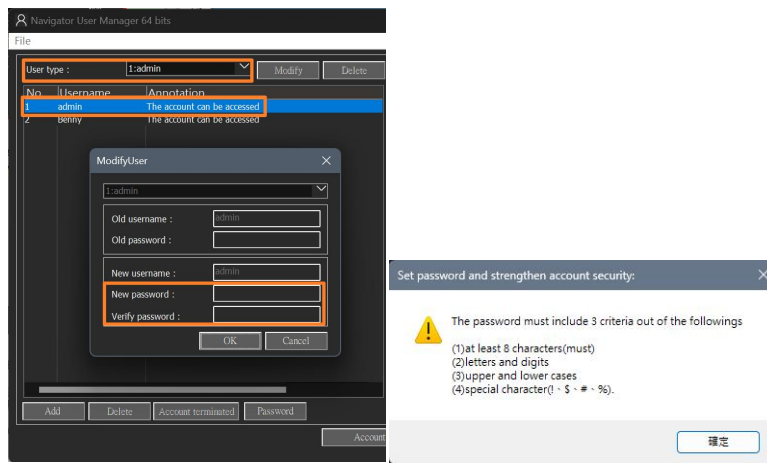

Chapter 1.1 Add a User

To add a user, click the Add button. In the Add User Group dialog box, enter the required information. Remember to choose user access level before you press OK.

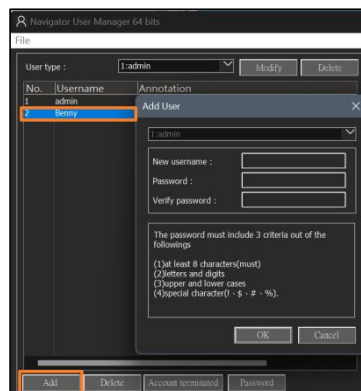

Chapter 1.2 Modify an Existing User

To modify an existing user, choose a user and click the "Modify" button. Here you may change the password of this user.

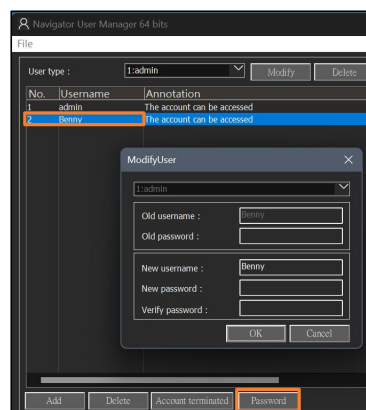

Chapter 1.3 Delete a User

To delete a user, choose a user, press “Delete”, and click “OK”.

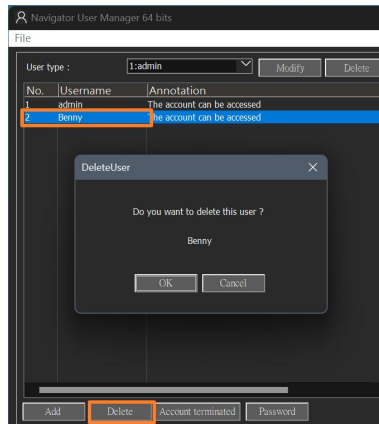

Chapter 1.4 User Authorization

Features supported by Navigator can be assigned to each user. To enable a feature for a user, click “Operation”, and check whichever boxes to which you want the user to have access.

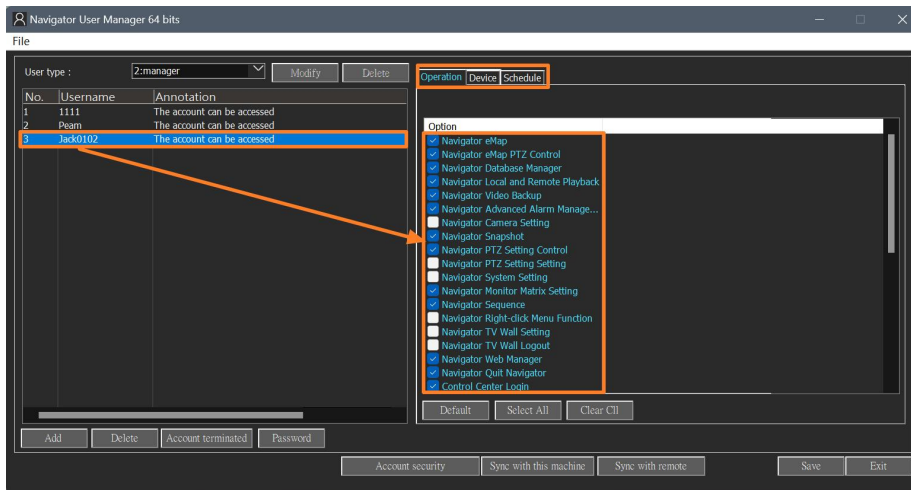

Chapter 1.5 Operation Access Management

Select user type and click on user. Then, click on “Operation” option, please check the required permissions. Then click on “Save” and “Exit” to save the settings.

Note: Please restart the application settings after closing the Navigator software on the NAV&NCC host.

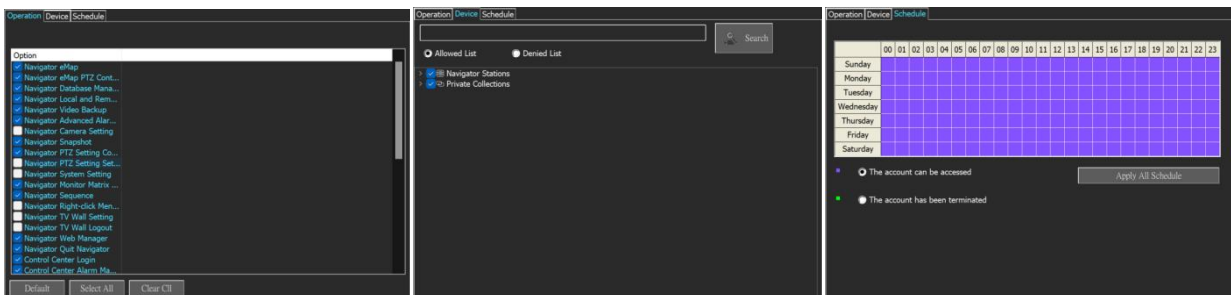

Function Permission Icons			
	Navigator eMap		Control Center Login Permission
	Navigator eMap PTZ Control		Control Center Alarm Management
	Navigator Database Manager		Control Center Image Decoder Function
	Navigator Local and Remote Playback		Control Center Mosaic TVWall
	Navigator Video Backup		Control Center eMap
	Navigator Advanced alarm Management		Control Center IPSan
	Navigator Camera Setting		Control Center Device Management Report
	Navigator Snapshot		Control Station Settings
	Navigator PTZ Setting Control		View Manager Login Permission
	Navigator PTZ Setting Function		View Manager System Setting
	Navigator System Setting		View Manager Remote Playback
	Navigator Monitor Matrix Setting		View Manager Synchronous Playback
	Navigator Sequence		View Manager Video Backup
	Navigator Right-click Menu Function		View Manager PTZ Control
	Navigator TV Wall Setting		View Manager Sequence
	Navigator TV Wall Logout		View Manager eMap
	Navigator Web Manager		View Manager Modify Permissions
	Navigator The Software Power Down		import Views for Mosaic TVWall Feature
-	-		View Manager Alarm Output
-	-		View Manager Snapshot
			View Manager Window Close
			View Manager Window Minimize

Supplementary Description:

View Manager Modify Permissions	
	<p>Custom groups cannot be modified or deleted</p>

	<p>Locked when dragged to the canvas (to prevent layout changes).</p>
	<p>Unable to switch channels (for example, switching between CH1 and CH2).</p>
	<p>Channel settings restricted, except for audio output.</p>
	<p>The View Manager cannot modify or delete image group arrangement</p>

Chapter 2 System Settings

In System Settings , you will find a number of tabs that allow you to change the configurations of this software. Configure the settings to fit your requirements.

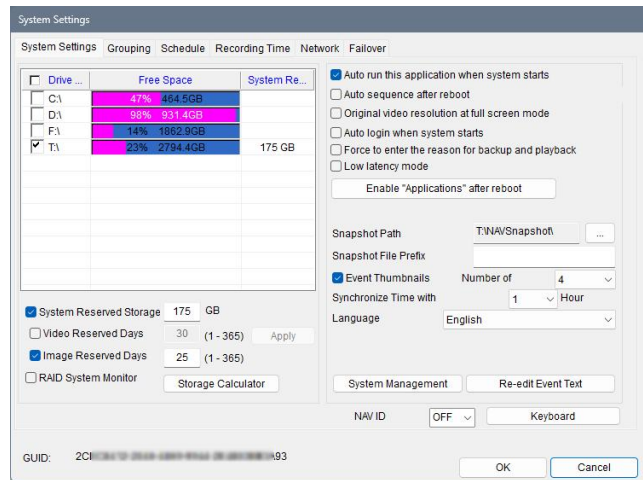

- Auto run this application when system starts: Launch Navigator automatically on system startup.
 - Note:** When additional NCC is installed, you can also set the automatic start time from here or match it with the AI Engine watchdog time.
 - Startup sequence time specification:
 1. NAV > NCC
 2. AIEngine = NAV or AIEngine < NAV
- Auto sequence after reboot: Perform group sequential display after a system reboot.
- Original video resolution at full screen mode: Use original video resolution in full screen mode.
- Auto login when system starts: Log in to Navigator automatically when the system starts.
- Force to enter the reason for backup and playback: Check to enter reasons for backup and playback.
- Low latency mode: When CPU load is too high, check this option to make the video smoother.
- Enable "Applications" after reboot: Unique software or custom tools, automatically enabled when the Navigator main program is opened.
- Snapshot Path: Set the path for snapshot storage.
- Snapshot File Prefix: Add the prefix character of the file name.
- Event Thumbnails: Enable screenshots of alert events, such as: AI license plate, traffic behavior, face recognition screenshots, etc.
- Synchronize Time with: Automatically synchronize with the computer clock.
- Language: Choose your language from the drop-down list.
- GPU Decode and Display: GPU display decoded output.
- Smart anti-aliasing: Smart channel image edge smoothing.
- Memory Management: Memory saver management.
- NAV ID : 931 Keyboard ID, default is OFF.
- System Reserved Storage: Click on Circular Recording box to enable, and the maximum hard disk space can also be set.
- Video Reserved Days: Select the number of days to retain recordings.
- Image Reserved Days: Select the number of days to retain screenshots (Below the snapshot path).
- Raid System Monitor: Can monitor the disk array status, support LSI MegaRAID, Intel® Matrix RAID.
- System Reboot: Check and set the time you want the system to reboot every day.

Note:

1. It is recommended that system drive is not set as video destination drive.
2. Snapshot Path Please specify C: Drive other than the system hard drive and create a new folder for alarm snapshot storage.
3. Snapshot Path is in C drive and does not support alarm screenshot function. Attention!

Chapter 3 Programming Tool

Provide unique software tools, users can decide whether to automatically enable below functions after the Navigator main program is turned on.

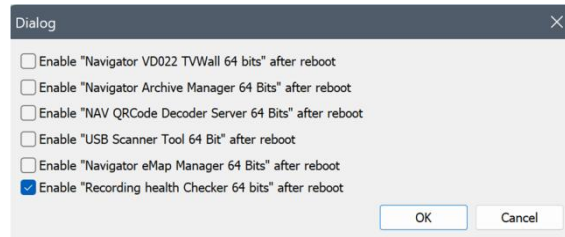

- Navigator TVWall 64 bits : Video decoder can be used as a virtual matrix system in large monitoring systems (Virtual Matrix System); Check on “**NAV NETStreamingType**” box, you can pull the Navigator image directly into the group for monitoring and construct the entire large surveillance TV wall. When Navigator is opened, video decoder TVWall will be enabled automatically.
- Navigator Archive Manager : You can back-up the PC image of Navigator Software to the network storage device. When Navigator is opened and this option is enabled, the archive manager will be automatically opened.
- NAV QRCode Decoder Server : A new program will be launched soon. When Navigator is turned on and this option is enabled, the QRCode server will be automatically connected.
- USB Scanner Tool : Handheld scanners support 1D and 2D barcodes, and bring more rapid productivity and performance to the retail industry. They are suitable for a wide range of applications in retail, healthcare and post offices. When you open Navigator and check this option will USB Scanner Tool automatically.
- Navigator eMAP Manager : When you open Navigator and this option is checked, the eMAP Manager will be automatically enabled.
- Recording health Checker : If the power is off due to abnormal power failure, the image may not be stored or the data may be damaged. If this option is checked, the recording health checker tool will be automatically enabled. Support manual custom time check and generate health status report

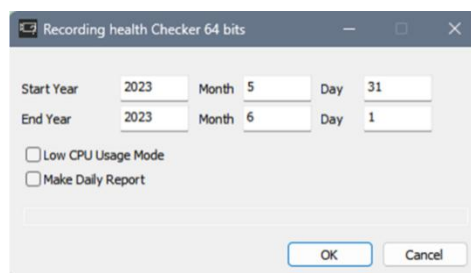

- Start Year : Check start time year/month/day.
- End Year : Check endtime year/month/day
- Low CPU Usage Mode : Scan all, regardless of whether there are files in the video file folder or not.
- Make Daily Report : Provide a report after the scan is completed
- NCC: When opening Navigator, check this option will automatically activate Navigator Control Center.

Chapter 3.1 GPU Graphics Decode Setting

With hardware advancement in high-resolution videos, in addition to bringing better picture quality, it also brings more CPU usage. The GPU decoding method enables the system to perform multitasking operations while viewing CCTV. At present, GPU decoding supports NVIDIA 1030-level graphics cards and Intel® 530-level built-in displays. It also supports GPU hardware decoding functions for both NVIDIA graphics cards and built-in Intel displays. When the host has both NVIDIA graphics cards and motherboard Intel® built-in, Navigator optimizes resources based on system usage to achieve more channels or high-frame devices.

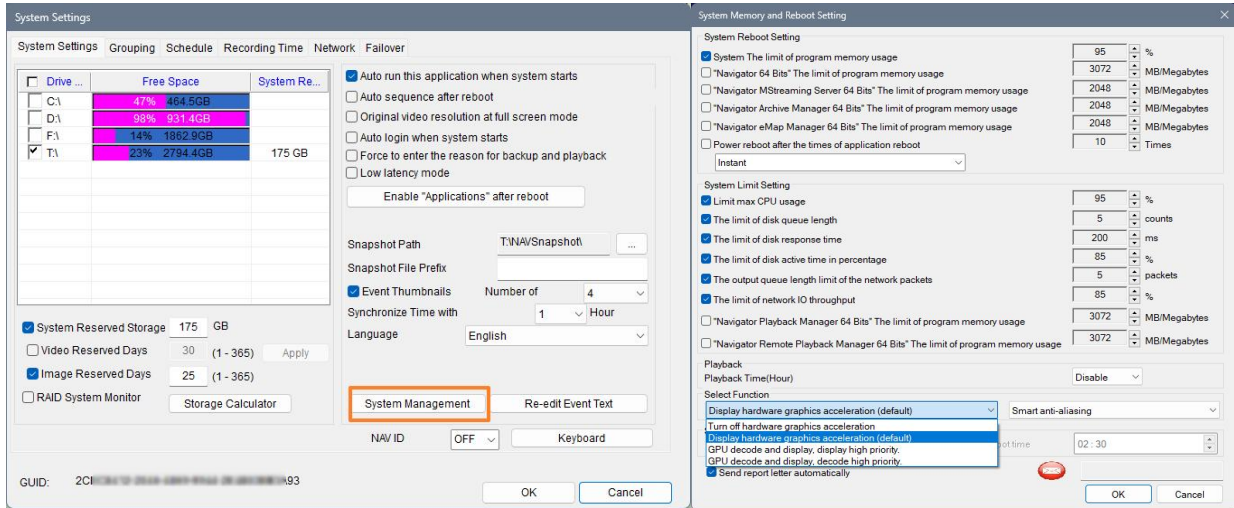

- Turn Off Graphics Hardware Acceleration
Turn off Direct3D software decode acceleration, GDI traditional graphics mode display, and support old type without Direct3D graphic card.
- Graphics Hardware Acceleration Display(Default)
Turn on CPU software decode acceleration, Direct3D graphic mode display, and supports new Direct3D graphic card.
- GPU Decode And Display, Display High Priority
Turn on GPU hardware decode acceleration, graphic display is prioritized.
- GPU Decode And Display, Decode High Priority
Turn on GPU hardware decode acceleration, decode display is prioritized.

Note: If a user purchased a new NVIDIA graphics card, they need to update to the latest version of Windows 10. Please note that not all versions can be directly upgraded to the latest one. If Windows Update does not provide the latest version continuously, it is recommended to seek technical assistance from the original manufacturer to reinstall the latest operating system version.

Note: Standard Video Display Card with Windows Version		
NVIDIA Chip Architecture	Windows 10&11	NVIDIA Display Card Model (Support super*Ti)
Pascal Architecture GraphicsCard	Version 1607 or later	10 Series:GT1030,GTX1050,GTX1060,GTX1070, GTX1080,TITAN X/XP
Turing Architecture GraphicsCard	Version 1709 or later	16 Series:GTX1650&1660
		20 Series:RTX2060&2070&2080,Titan RT
		Quadro Series:RTX 4000,5000,6000,8000
Tesla Series: Tesla T4		
Ampere Architecture Graphics Card	Version 1803 or later	30 Series:RTX 3060,3070,3080,3090
Ada Lovelace Graphics Card	Version 22H2	40 Series: RTX 4060,4070,4080

Note: If you want to experience more real-time video channels and high-definition video cameras, please upgrade your graphics card and physical memory. The recommended NVIDIA graphics card memory is 4GB or more, and recommended physical memory is 32GB or more.



Chapter 3.2 Memory Protection and Watchdog Setting

When a computer system has multiple programs running at the same time, the system often divides the main memory into several areas and assigns them to each program. In order to avoid mutual interference when the program is running, the Navigator watchdog memory protection control mode must be used to limit the activity in the memory area of each program. This is the memory protection.

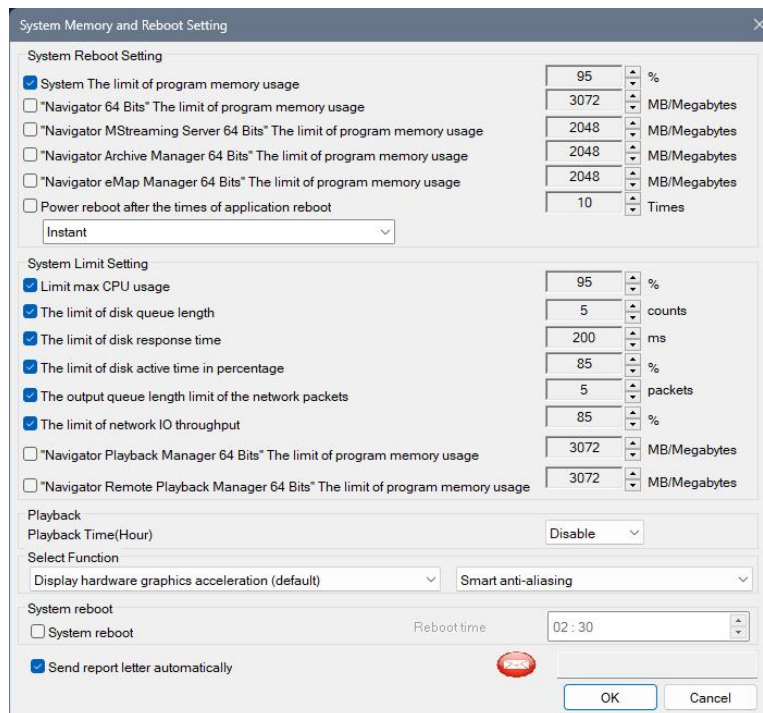

Memory Protection Setting:

- System memory use limit: preset is 80%
- “Navigator 64 Bits” memory use limit: NVR Software preset max limit is 4096MB.
- “Navigator MStreaming Server 64Bits” memory use limit: Streaming Server, preset max limit 2048MB.
- “Navigator Archive Manager 64Bits” memory use limit: Archive Manager, preset max limit 2048MB.
- “Navigator eMap Manager 64Bits” memory use limit: eMap, preset max limit 2048MB.
- Restart the power after restarts the software repeatedly: restart the computer after repeated back-end AI Engine server disconnection detections.

Watchdog detection reopening mechanism:

- Instant : When the system detects an abnormality, the software restarts immediately.
- Reboot at system reboot time: When the system detects an abnormality, the software automatically restarts at preset 00:00 night time.

Host status database

- Limit max CPU usage: Set CPU usage to 80%
- Disk queue length limit: preset limit5 counts
- Disk response time limit: preset max limit200ms
- Disk active time percentage limit: preset max limit 85%
- Network packets output queue length limit: preset max limit 2 packets
- Network IO throughput limit: preset max limit 70%
- "Navigator Playback Manager 64 Bits": preset max limit 2048MB.
- "Navigator Remote Playback Manager 64 Bits": preset max limit 2048MB.

Note : When the system detects an abnormality 3 times consecutively, and still detected within 10 minutes, the computer will restart.

Chapter 4 Navigator Login

From the Navigator main menu, please click on desktop  button to access the Navigator monitoring screen.

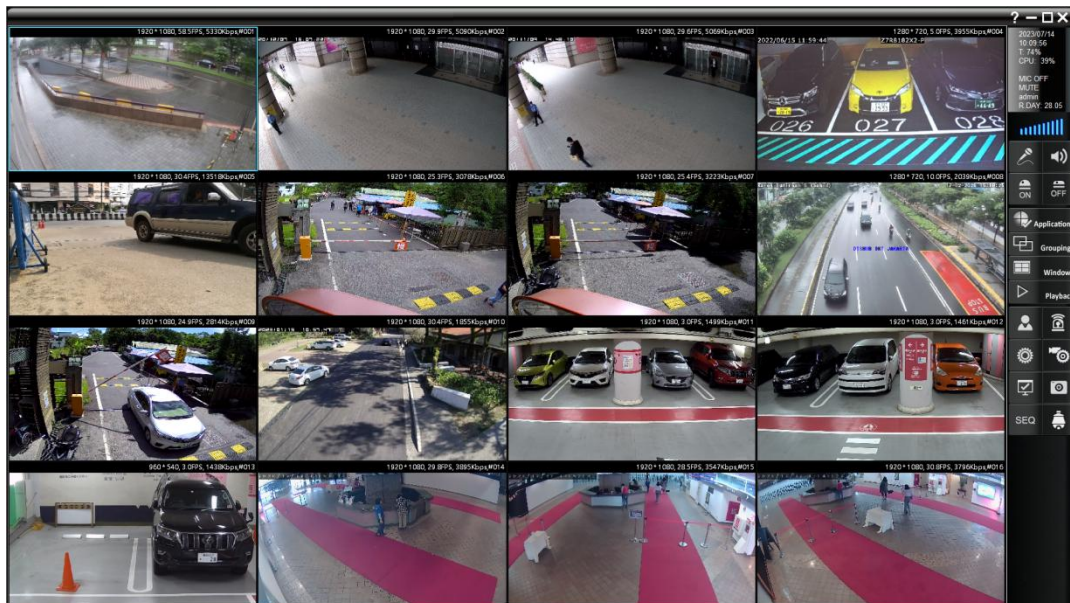

Chapter 4.1 How to Add a Device to Navigator

The Navigator supports IPScan protocol. IPScan protocol is convenient for discovery of NAV, NVR/DVR, and IP cameras in the network.

Chapter 4.1.1 Add a New Device

To add a new device, select any channel and click the “Properties” icon . Click the “Find Device” button to open IPScan, a tool that helps you find all devices in your network. Choose the device you want to use and press “Close”, and you will see a prompt window asking “Do you want to auto set the IP/DNS and the host post?” Click “Yes”, and the application will automatically complete all the settings for you.

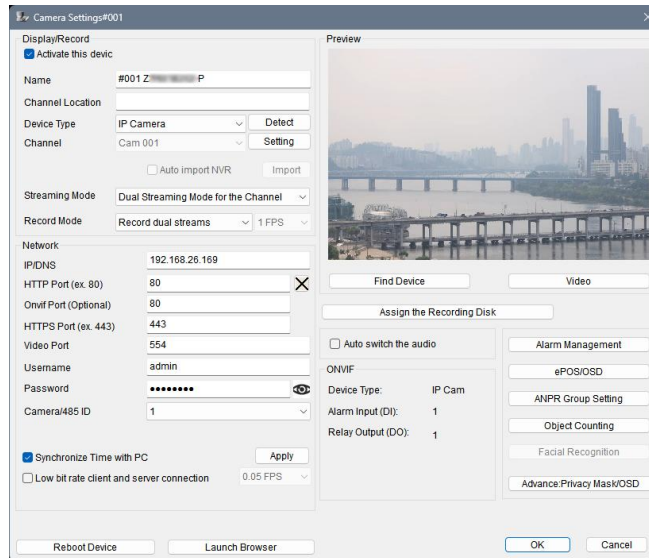

The configurable settings in Properties are listed as followed:

- Find device: IPScan scans IP network area, all Navigator/DVR/NVR/IPCAM and other devices.
- Video: After inputting device IP setting, click on “Video” to see the live image preview.
- Activate this device: Check or uncheck to enable or disable the camera.
- Name: Camera name displayed on top of the live video channel.
- Location: Location of the camera installed.
- Device type: Please select "IP Camera" for the camera, select "DVR/NVR-H.264" for DVR/NVR device, or click "Detect" to automatically adjust the settings..
- ONVIF: Most of the ONVIF devices are communicated via HTTP port 80. If the target ONVIF is not communicated by HTTP port 80, our NAV recorder provides extra ONVIF port for communication purposes.
- Streaming Mode: It can select single or dual stream output with two different bit rate image.
- Record mode: It can select main stream/sub stream recording or dual stream, and low bitrate recording mode.
- Assign recording mode: Assign different hard disk for recording, channel distribution mode recording.
- IP/DNS (**required**): IP address of the device.
- HTTP Port: HTTP port number of the device.
- Video Port: DVR’s video port number/IP camera’s RTSP port number.
- Username
- Password
- Image size: The source video size of the device.
- Camera/485 ID: IP Fast Dome RS-485 ID.
- Synchronize Time with PC: Synchronize time with the local PC.
- Low Bitrate client server connection: When check, save live image bandwidth of IP channel connected to HTTP Port.
- Alarm Management: Adjust input and output for alarm management setting.
- ePOS/OSD: Set up connected ePOS/OSD device.
- ANPR Group Setting: Can add license plate’s allowed list and denial list.
- Object counting: Set up object counting function.

- Facial recognition: When a face is detected, will take screenshot of detected face.
- Reboot device: Re-start the device.
- Launch browser: Device web page setting.

Note: RS-485 camera ID (1 to 128) must match the ID setting of the IP Fast Dome. The software may not control the PTZ movement if the ID setting is incorrect.

Once you complete the above settings, you can click on **“Video”** to test if the device is working properly. For information of the default username and password, please see Appendix for details.

Chapter 4.2 Set up Hard Disk Recording

When the system is a non-RAID hard disk, you can select different channels to record on other hard disks. The purpose is to reduce the recording load of a single hard disk, or to save video of important channels.

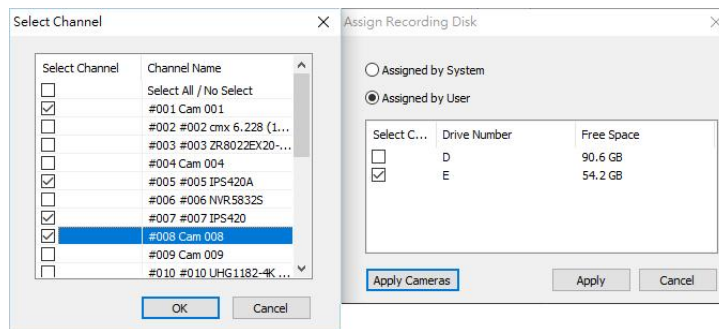

Note: By default, the system will only move on to the next disk after the disk recording space is full.

Chapter 4.3 Device Type

For video streaming, there are several device types to choose from:

Device Type	Description
H.264 AVC IP Mini Dome	D1 H.264 IP PTZ camera stream
IP Camera	IP Camera with H.264/H.265 stream
DVR/NVR-JPEG	DVR/NVR low bandwidth snapshot stream
DVR/NVR-H.264	DVR/NVR H.264 stream
DVR 2B/2C Series	DVR 2B/2C series stream
AHD/DHD Series	AHD/DHD DVR series stream
Third-Party AHD/DHD Series	Other brand AHD/DHD DVR series stream
NAV Live Streaming	NAV live image streaming
NAV USB/P2P Live Streaming	USB camera or NAV P2P live streaming
NAV-JPEG	NAV JPEG stream
NAV-JPEG Poster	NAV-JPEG Poster
Low Bitrate IP Camera	Low bandwidth I frame camera connection
Low Bitrate DVR Camera	Low bandwidth I frame NVR/DVR camera connection
Snapshot Device	Low bandwidth JPEG snapshot stream
Manual	Manual input of camera URL stream
Third-Party ONVIF Camera	Other brand ONVIF protocol stream

Manual RTSP	RTSP image stream
Screen Capture	Screen capture streaming features
IPCamera HTTPS	IPCamera HTTPS series streaming
NVR/DVR-H264 HTTPS	NVR/DVR-H264 HTTPS series streaming
Multi-Sensor IP Camera	Multi-Sensor streaming
Third-Party DVR/NVR	Other brand DVR/NVR series models streaming

Chapter 4.3.1 NAV IPCAM HTTPS Connection Method

1. IPCAM IE Web Login

Network-> HTTPS Service ->-> Check "Enable"->Create a certificate

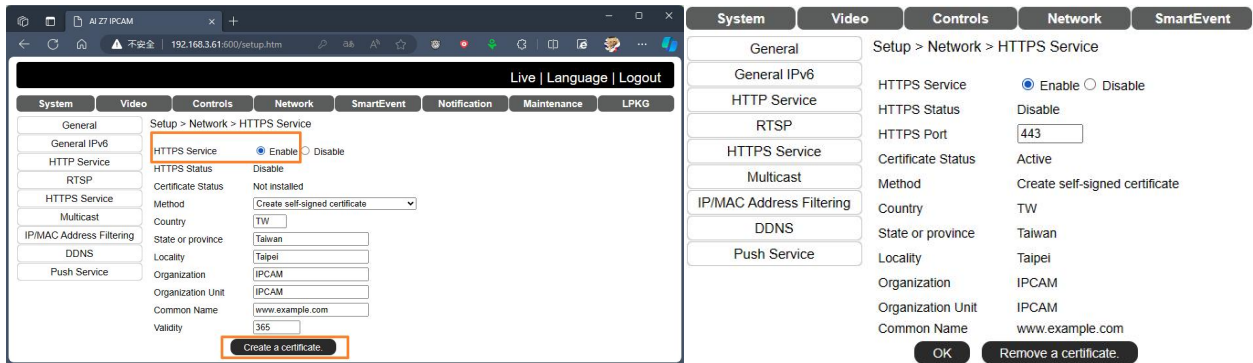

2. NAV IPCAM HTTPS Connection Method

Camera Settings->Device Type ->IPCam HTTPS

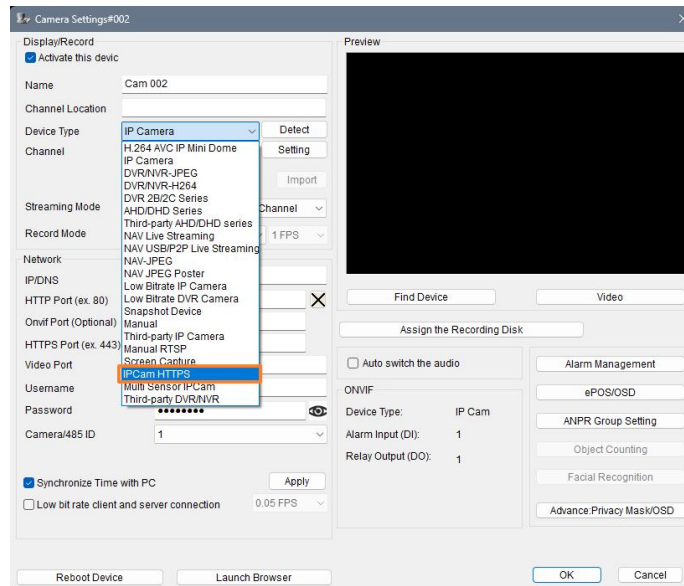

Chapter 4.4 ONVIF Settings

To use RTSP streaming, first you need to set up the ONVIF protocol:

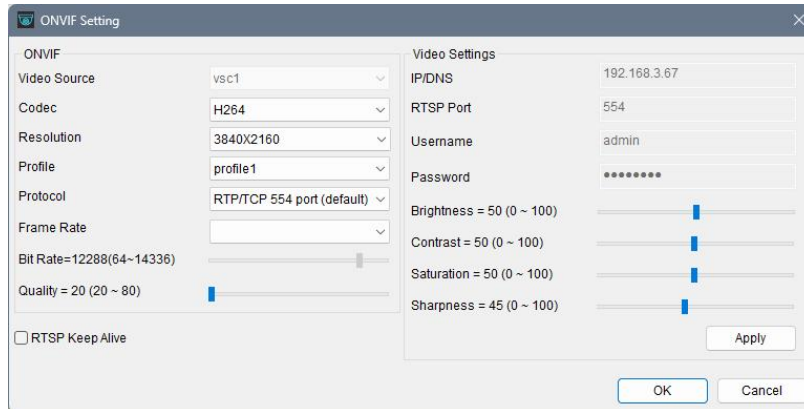

- Codec: H.264&H.265 mode, JPEG mode.
- Resolution: Live image picture resolution.
- Profile: A user can select different streaming profiles such as H.264&H.265 1080p/480p or MJPEG 480p/CIF.
- Protocol: Streaming protocol such as RTP/UDP, RTP/TCP, or RTP/TCP/HTTP.
- Frame rate: Live image frame rate.
- Bitrate : Image transmission bitrate.
- Quality: Live image picture quality.
- RTSP Keep Alive: The function derived from the disconnection of the traditional type cameras (the current default does not need to be checked).

Note: ONVIF settings are only available for our ONVIF camera.

Chapter 4.4.1 NVR/DVR P2P Connection

To connect through our NVR/DVR P2P, please open the NAV camera settings option, select "NAV USB/P2P Live Stream", enable NVR/DVR->Network Settings, and set the following:

1. P2P Account Number
2. Username and Password

Copy or import into NAV camera setup options.

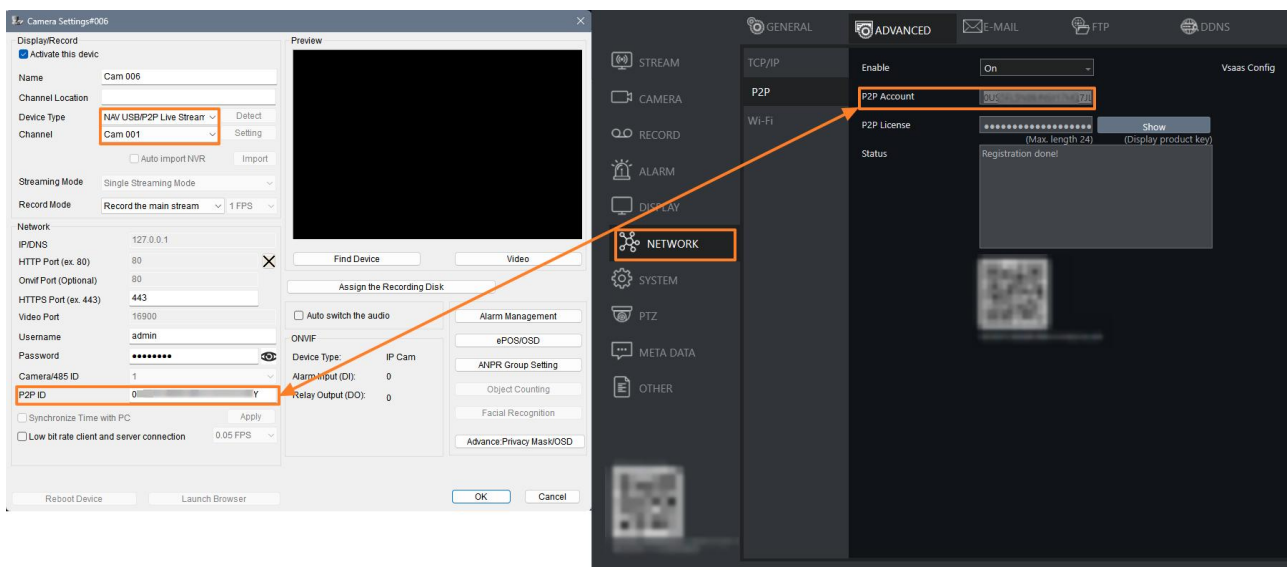

Chapter 4.5 Find Device

IPScan utility can scan through all IP address in the LAN to locate devices.

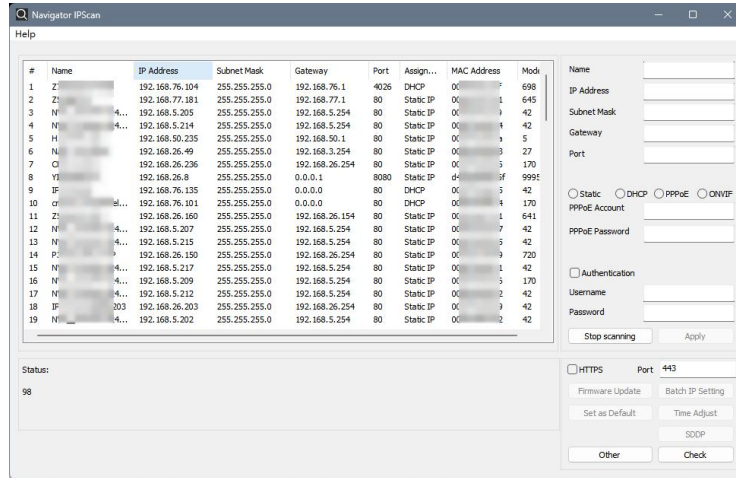

Select a device in IPScan and click “Close” to set up the device. All the device information such as IP address and port number will be automatically detected by Navigator.

You can also manually add devices of IP Fast Dome, IP camera, video server, or DVR .

Note: IPScan can only work under a LAN environment and does not support an Internet environment.

Chapter 4.5.1 How to Change Device Names in IPSCAN

Search for the desired device and mouse click on it. After the selected state appears, enter a new name for the device, tick on "Authentication" box and enter the account username and password to apply. The device name should be updated afterwards.

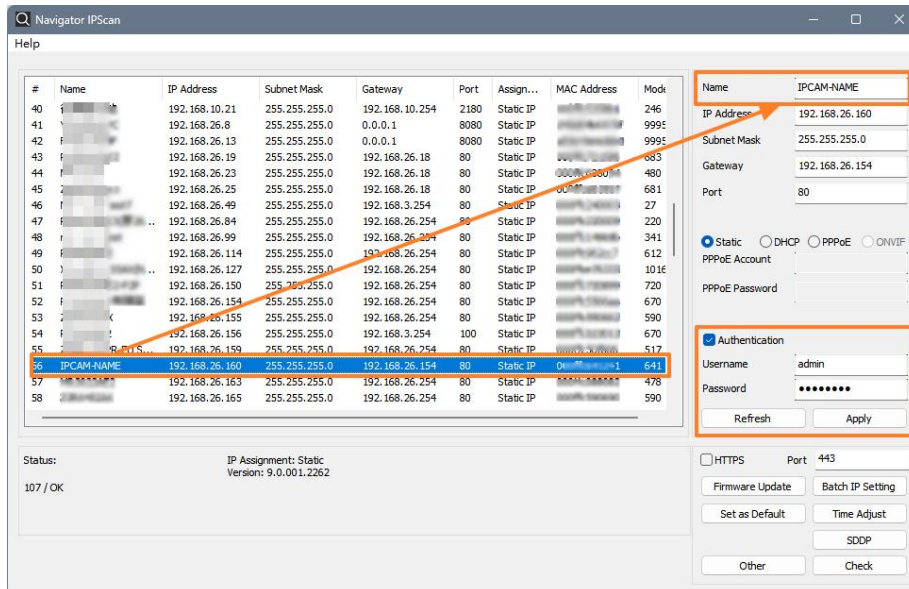

Chapter 4.5.2 Change the Device IP/HTTP/HTTPS Port Number in IPSCAN

Search for the desired device and mouse click on it. After the selected state appears, please modify the IP address, subnet mask, gateway, and HTTP/HTTPS port. Tick on "Authentication" box and enter the account username and password to apply. The device IP address should be updated afterwards.

Chapter 4.5.3 Update Device Firmware in IPSCAN

Search for the desired device and mouse click on it. After the selected state appears, click on "Firmware Update" and wait for 30 seconds or more until a message displayed update is successful.

- Use Encrypt File: Whether to select the encrypted firmware. (Please refer to the device provided encrypted firmware version.)
- Device type:
- Camera: Camera firmware.
- AI: Edge front-end camera firmware.
- Configure Parameter: Export camera settings.

Chapter 4.5.4 Batch IP Setting in IPSCAN

Search for the desired device, press “CTRL” on the keyboard to select the N devices, click on “Batch IP Setting”, and wait for 30 seconds or more until a message displayed update is successful.

- DHCP: Automatically assign a dynamic IP address.
- Assign Username and Password At First Time Out of Box: The account password of the device is restored to its initial value.
- Login the Device after Password Creation: Enable the camera authentication.

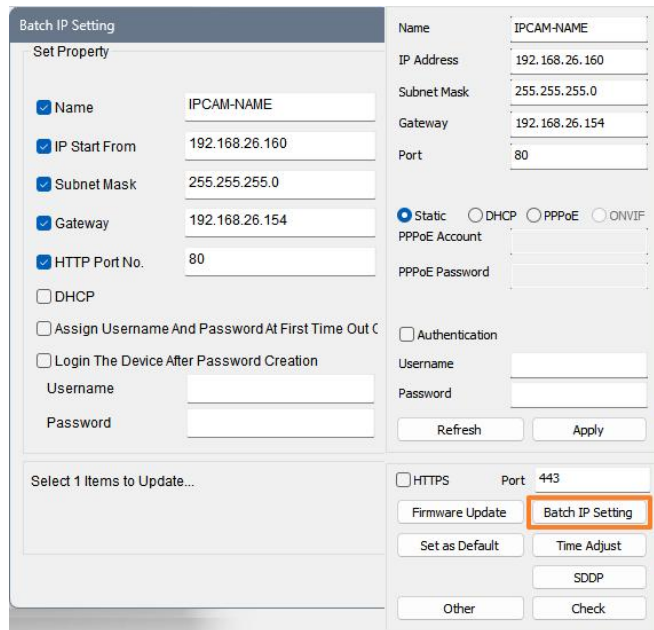

Chapter 4.5.5 Restore a Device to its Default Settings in IPSCAN

Search for the desired device and mouse click on it. After the selected state appears, click on “Set as Default”, and wait for 30 seconds or more until a message displayed update is successful.

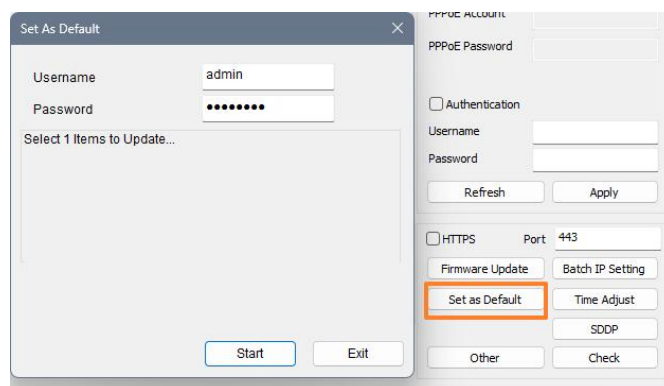

Chapter 4.5.6 Enable or Disable the SDDP Function in IPSCAN

Search for the desired device and mouse click on it. After the selected state appears, click on “SDDP”, and wait for 30 seconds or more until a message displayed update is successful.

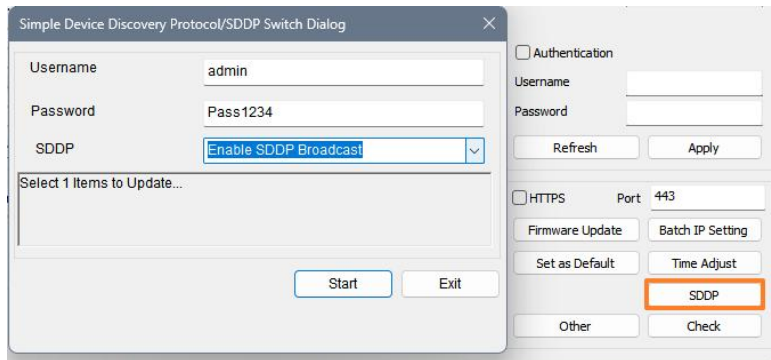

Chapter 4.6 Alarm Input Management

Navigator supports a wide range of alarm inputs, which may be different according to various camera models:

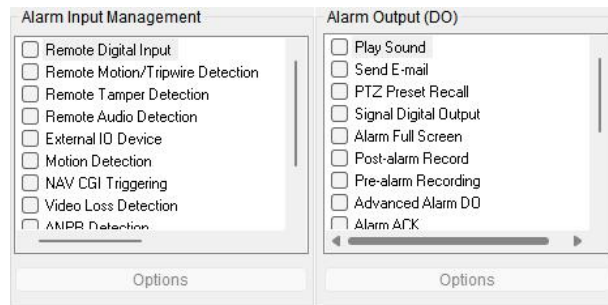

Alarm input management	Description
Remote Alarm In	If the camera supports digital input, once triggered, Navigator shall be notified.
Remote Motion/Tripwire Detection	If camera supports motion/tripwire detection, once triggered, Navigator shall be notified.
Remote Face Detection	If camera supports face detection, once triggered, Navigator shall be notified.
Remote Tamper Detection	If camera supports tamper detection, once triggered, Navigator shall be notified.
Remote Audio Detection	If camera supports audio detection, once triggered, Navigator shall be notified.
External IO device	If external IO is use, Navigator shall be notified.
Motion Detection	This is local Navigator motion detection setting.
Nav CGI Triggering	Navigator CGI triggering
Video Loss Detection	The navigator image has no signal detected, if channel suddenly video loss, navigator shall be notified.

License Plate Recognition Detection	Navigator AI license plate recognition detection, once the Navigator is triggered, there will be a license plate recognition OSD notification.
Remote LPR Detection	Navigator remote license plate recognition detection, once triggered, navigator will have license plate recognition OSD notification.
Face Recognition Detection	Navigator face recognition detection, once triggered, navigator will have face recognition OSD notification.
QRCode Detection	Navigator QRCode detection, once the Navigator is triggered, there will be QRCode OSD notification
AI Behavior Detection	Navigator AI traffic behavior and object detection, once the Navigator is triggered, there will be traffic behavior alert notifications.

Chapter 4.6.1 Remote IP camera with digital I/O

If the IP camera is equipped with a DI/DO interface, enable "Remote Alarm Input" in the alarm input list, and then check "Enable Alarm Input" to trigger the IP camera digital output.

Chapter 4.7 Alarm Output Management

The alarm output function supports a variety of different alarm responses, which can be used for motion and remote motion alarm detection management. The alarms that can be triggered may vary depending on the camera model.

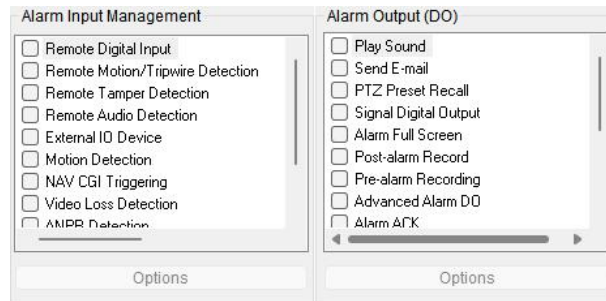

Alarm Output Management	Description
Play Sound	When an alarm triggers or an event occurs, a user defined wav audio file will be played.
Send Email	Send email notification
PTZ Preset Recall	Set PTZ to move to preset position
Signal Digital Output	Send IPC digital output
Alarm Full Screen	When alarm triggered or an event occurs, the channel is displayed in full screen.
Post-alarm Record	After alarm occurs, will record for 5 seconds.
Pre-alarm Record	Before alarm occurs, will record for 1~10 seconds.

Advanced Alarm DO	Turn on DO device, i.e. IP Camera's DO, MOXA 1200 Series
Alarm ACK	Alarm acknowledgement after the alarm occurs, if the user has two monitors, it will automatically pop up.
Alarm Snapshot	Alarm snapshot
Text Overlay	Users can custom input Chinese and English special symbols displayed in the channel screen
App Cloud Push Notification	When an alarm triggers or an event occurs, navigator will send push notification to mobile app.
NCC TVWall ACK	NCC Mosaic TVWall ACK Alarm confirmation function
NCC Emap Center Alarm	NCC Emap Center eMap control alarm trigger
NCC Play Audio	View Manager trigger the alert sound after the alarm is set off
NCC Global Alarm Settings	NCC Global alarm system triggered at the same time

Chapter 4.7.1 Advanced Alarm DO

You can set IP Camera's DO and MOXA Uport on advanced alarm outputs, triggering warning lights or buzzers and gate control switches.

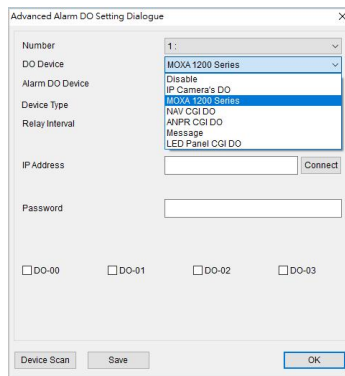

Chapter 5 MOXA-ioLogik-E1212Control Box

The ioLogik E1200 industrial Ethernet remote I/O has two embedded Ethernet switch ports that allow information to flow to another local Ethernet device or connect to the next ioLogik in the daisy-chain. Applications such as factory automation, security and surveillance systems, and tunnel monitoring, can make use of daisy-chained Ethernet for building multi-drop I/O networks over standard Ethernet cables.

Attention! MOXA control box with Navigator software is only up to version 3.0.0.170. Please contact technical support team for further support.

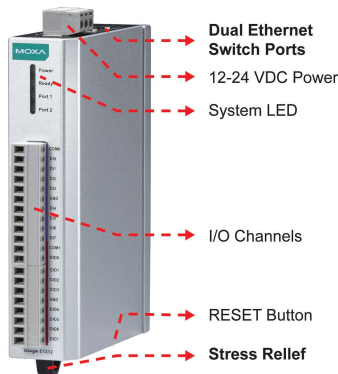

Note: The Reset button restarts the server and resets all settings back to factory default. Use a sharp object, such as a straightened paper clip, and press down the RESET button for 5 seconds. Once the READY LED turns green again, the factory defaults will be loaded. Then you can release the RESET button

Chapter 5.1 MOXA General Settings

In General Settings page, you can specify the server name and location to help you distinguish between different ioLogik E1200 devices. You can also configure the Modbus / TCP timeout interval or enable communication watchdog function.

Chapter 5.2 MOXA Ethernet Configuration

In Ethernet Configuration page, you can set a static or dynamic IP address for the ioLogik E1200 and configure subnet masks and gateway addresses.

Chapter 5.3 MOXA Web Console IO Setting

The status of each DI (digital input) channel appears on the DI channel setup page.

DI Channel Settings

Refresh page

DI Channel	Mode	Status	Filter	Counter Trigger
DI-00	DI	OFF	100.0 ms	--
DI-01	DI	OFF	100.0 ms	--
DI-02	DI	OFF	100.0 ms	--
DI-03	DI	OFF	100.0 ms	--
DI-04	DI	OFF	100.0 ms	--
DI-05	DI	OFF	100.0 ms	--
DI-06	DI	OFF	100.0 ms	--
DI-07	DI	OFF	100.0 ms	--
DI-08	DI	OFF	100.0 ms	--
DI-09	DI	OFF	100.0 ms	--
DI-10	DI	OFF	100.0 ms	--
DI-11	DI	OFF	100.0 ms	--

Chapter 6 IP Camera IE Webpage IVS Tripwire Detection

In IP camera web page settings, please go to **Advanced mode** → **IVS** → **Advanced Tripwire Detection**

Enable the Advanced Tripwire Detection to edit, and then set the tripwire area.
 When an object passes the tripwire, it will trigger, and the tripwire will change from green to red.

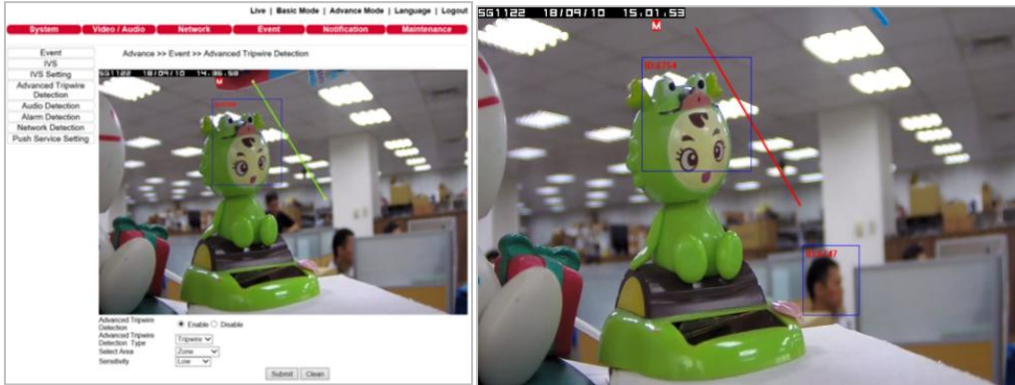

Chapter 6.1 Navigator Alarm Management Settings

1. Select IVS Camera Channel → Right mouse click → "Camera Properties" .
2. In Camera Setting Page, press "Alarm Management".

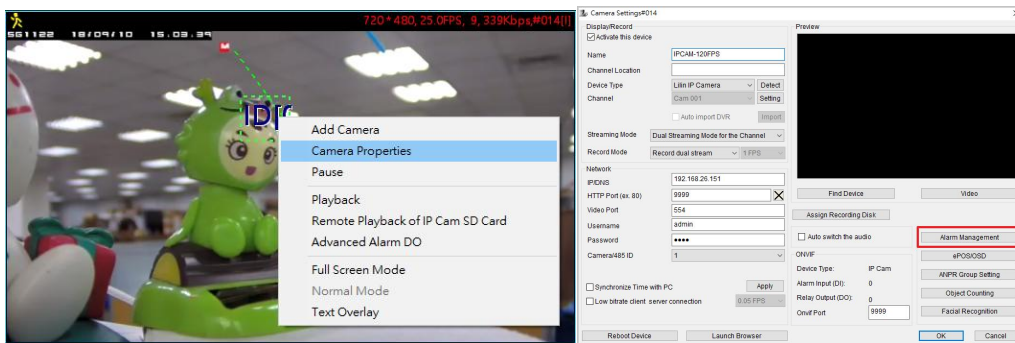

3. Alarm Input Management → Check "Remote IVS (Motion) Detection", Check at least one alarm output, For example: "Post Alarm Record", if you need MOXA DO action, then check "Advanced Alarm DO" and "Options".
4. Press "Device Scan" → MOXA Device Connection

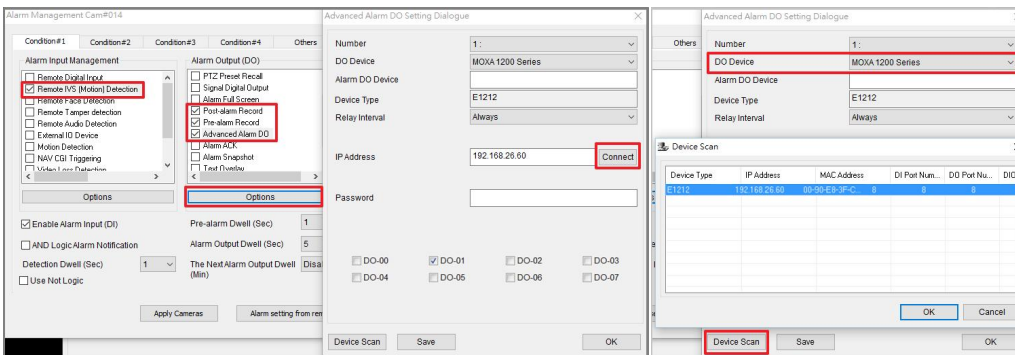

Note: The position of DO and MOXA box must correspond to each other to have normal DO output.

Chapter 6.2 External IO device

1. Please check “External IO Device” → “Options” → Select Device Type “MOXA 12XX” → “Device Scan”
2. Press “Device Scan” → MOXA Device Connection

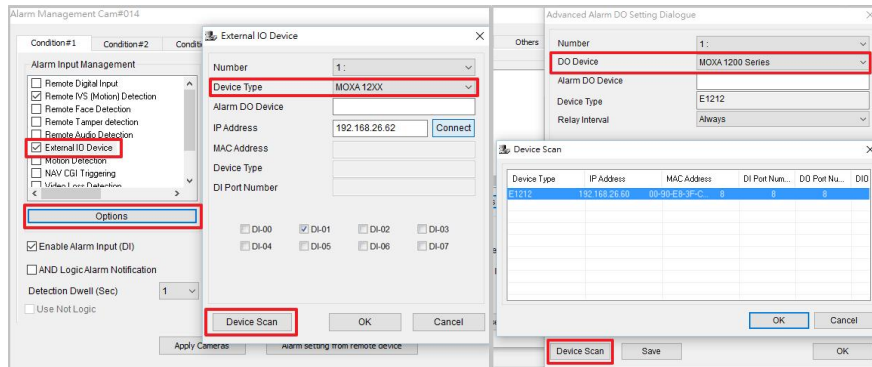

Note: DI stands for MOXA switch device.

Chapter 6.3 Alarm Acknowledgment

You need two monitors to enable alarm acknowledgment, one for Navigator and the other for alarm acknowledgment. Click the Monitor Setting icon and set the Alarm ACK Monitor to the second monitor.

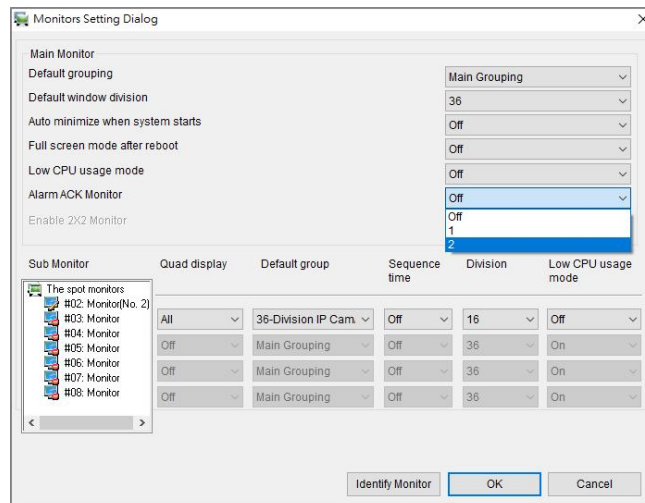

Navigator main monitor

Alarm acknowledgement monitor



Video is displayed on the Navigator alarm acknowledgement monitor you designated. To acknowledge the alarm, click the ACK OFF button at the bottom left corner of the Navigator alarm acknowledge monitor.



To setup the acknowledgement feature, check Alarm ACK in the alarm output list.

Chapter 6.4 Notify Navigator Installed on Other Computers

Third-party software can enable or disable videos on the alarm acknowledge monitor using the CGI commands provided by Navigator. See HTTPAPI.PDF on our official website for more details.

Chapter 7 Recording Settings

By default, Navigator starts continuous recording after an IP camera is connected. To change recording configurations, please read the following sections.

Chapter 7.1 Schedule Recording Settings

The recording schedule of Navigator can be set to Always, No Record, and Motion, and the time increment can be set down to an hour. To designate which hours to record, first choose the recording type (Always, No Record, and Motion), and then highlight as many boxes as you like in “System Settings”→”Schedule”.

Click Apply next to Apply All Schedule to apply the selected recording type to all days and hours. To apply a recording type to all channels, click “Apply All” for apply schedule to all channels.

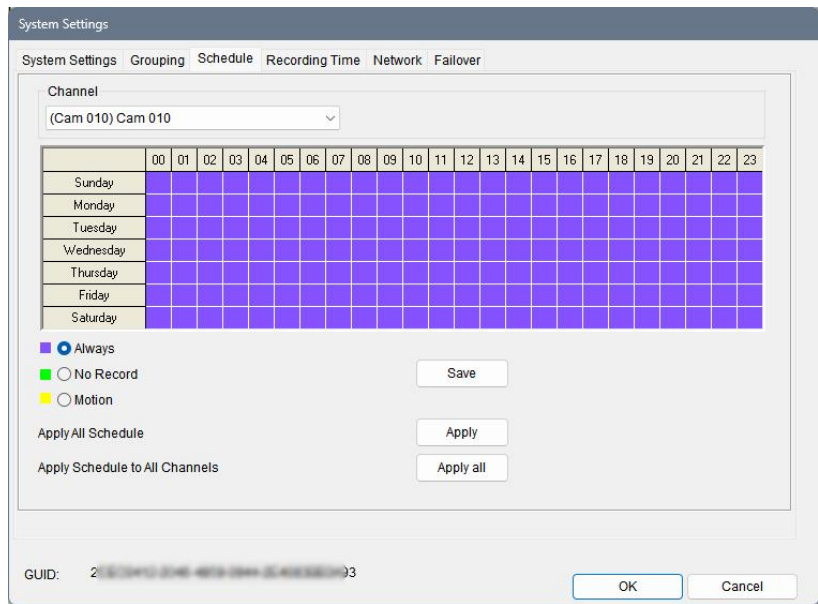

Chapter 7.2 Motion Detection Recording

To enable motion detection recording, click to open the Properties dialog box. Next, click Alarm Management and check Remote Motion Detection. Click Options to configure the settings. Navigator provides up to four user-configurable motion detection areas. Simply drag across any areas on the screen to define a motion detection area. Right-click to clear one or all designated areas. To adjust motion detection sensitivity, use the scroll bar at the bottom of the window. Motions that are detected within the highlighted areas will send an alarm to the system. Click Apply for the settings to take effect.

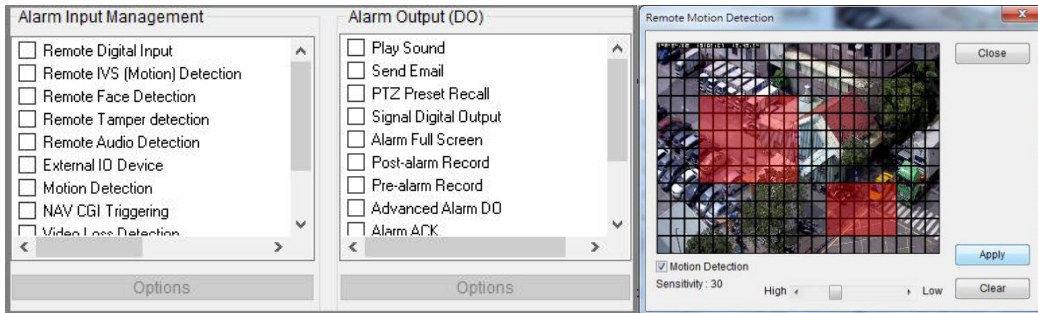

In the live monitoring mode, a “yellow man” appears in the channel if any motion events are detected.



Note: The use of remote motion detection can further reduce the CPU load of a Navigator PC, for this function utilizes the motion detection engine of the IP camera.

Chapter 7.3 Recording at System Startup

Check this option to start recording automatically every time you boot the system. It is not required to start recording manually. If a schedule is set, Navigator will begin recording according to the schedule at startup.

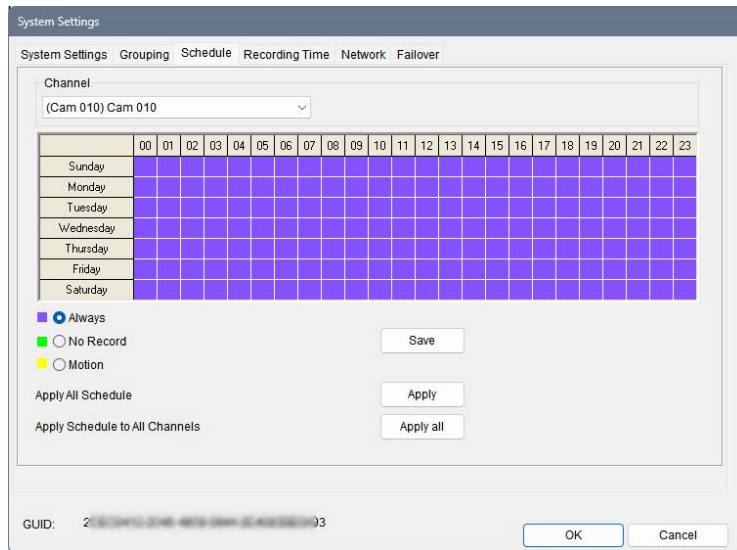

Chapter 7.4 Estimated Recording Days

To estimate the remaining storage capacity (days), a user can click System Setting and switch to the Record Time tab. Estimated recording day and time information will be displayed on the right side of the pane.

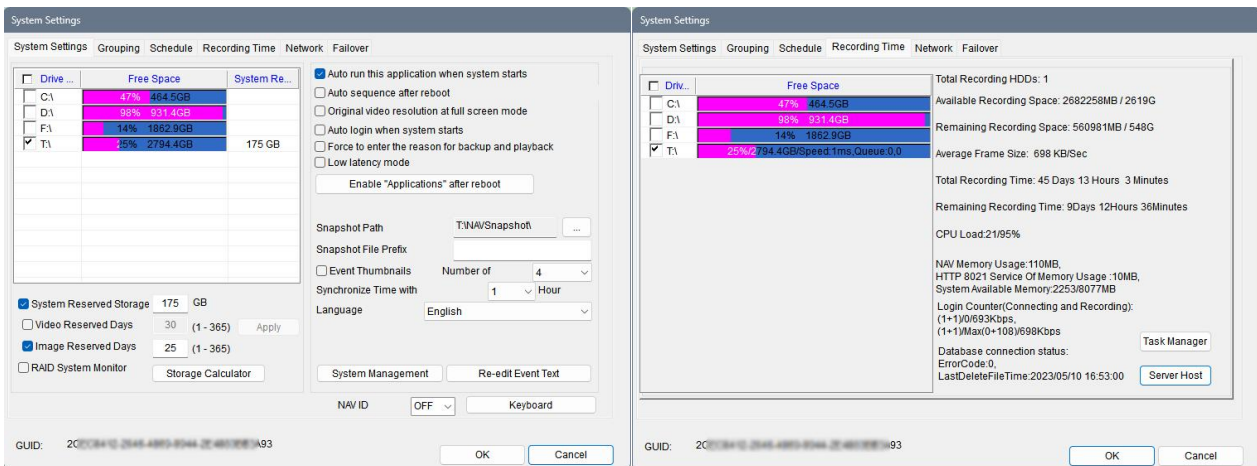

- Total Recording HDDs: Recording sector is checked.
- Available Recording Space: Total hard disk capacity minus the reserved space for loop recording (ie:873994MB/854G).
- Remaining Recording Space: The remaining recording space of the hard disk (ie:128MB/0G) ◦
- Average Frame Size: Hard disk recording data (ie:2323KB/Sec) ◦
- Total Recording Time: Recordable space ÷ average recording flow = total recording time (days/hours/minutes)
- Remaining Recording Time: Remaining recording space ÷ average recording flow = remaining recording time (days/hours/minutes) ◦

Chapter 7.5 Network Storage NAS

You are allowed to save recorded files on network storage such as iSCSI or NAS if the network storage supports “Network Neighborhood” protocol.

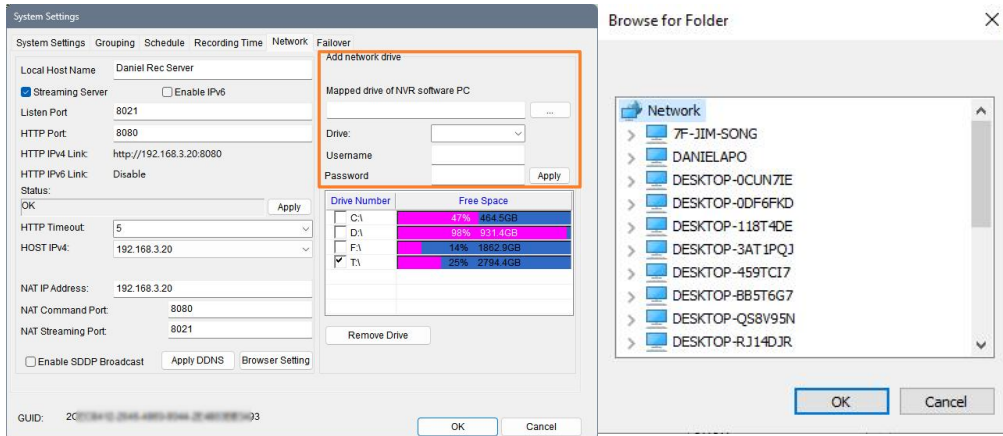

To do so, go to the Network tab. Click Add Network Drive, and select any network storage by clicking Mapped Drive of Navigator Software PC. Choose Apply when the network storage is selected. Check the storage you just added at the bottom of this window. Navigator will begin circular recording and save the files to the drive you selected.

Otherwise, you can go to My Computer→Tools→Map Network Drive. Please make sure that the Reconnect at logon option is checked to avoid losing connectivity.

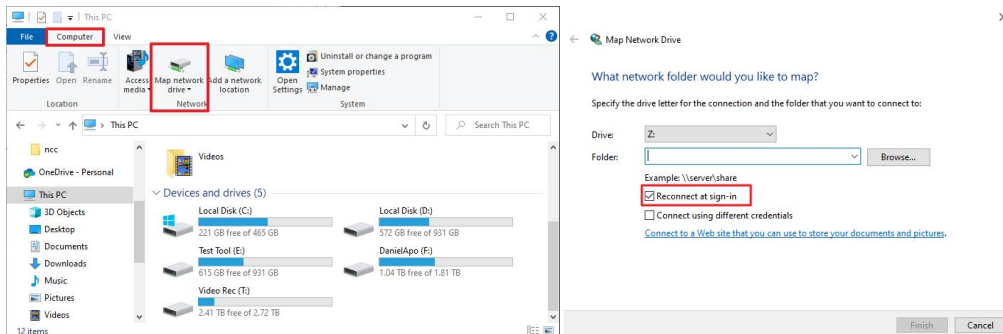

Chapter 8 Group Settings

Chapter 8.1 Grouping

Users are allowed to divide cameras or DVRs into groups based on their geographic locations or functions. You can easily view the videos recorded by the grouped devices. To create groups, enter System Settings and click Grouping and follow the followings steps:

Select a group type from the left pane and click the Right Arrow to create a group.

Click OK to save the settings.

Once the groups are set, you can easily switch between different groups.

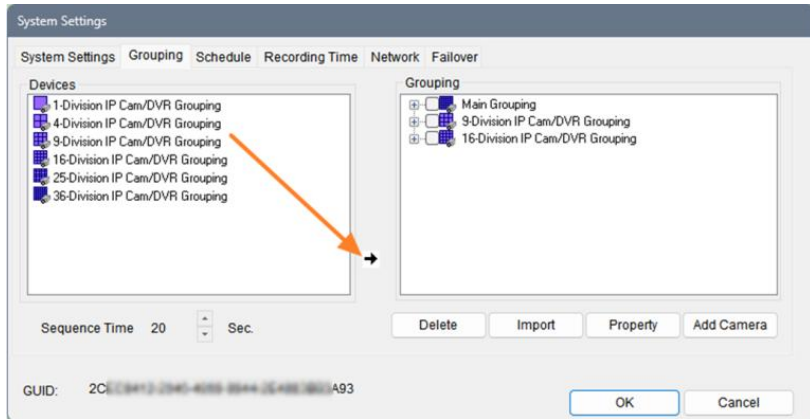

Chapter 8.2 Group Naming

To name a group, right-click a group and select “Property”. Enter the name you want to use into the text field.

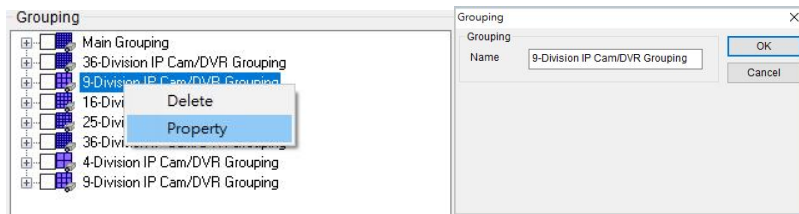

Note: Main grouping is system default name and cannot be modified.

Chapter 8.3 Auto add Devices in a Group

For saving time and convenient operation, user can automatically import IP Camera, DVR and other multiple devices in each grouping by clicking “Add Camera”. Each group supports 36 devices.

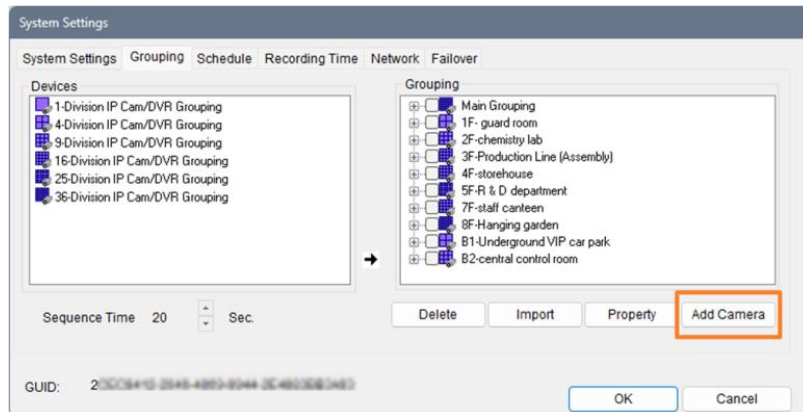

Chapter 8.4.1 Add an NVR or NAV Host

The maximum limit for each group on the NAV host is 36 channels. When importing remote devices, you can choose to import the first half or the second half of the devices.

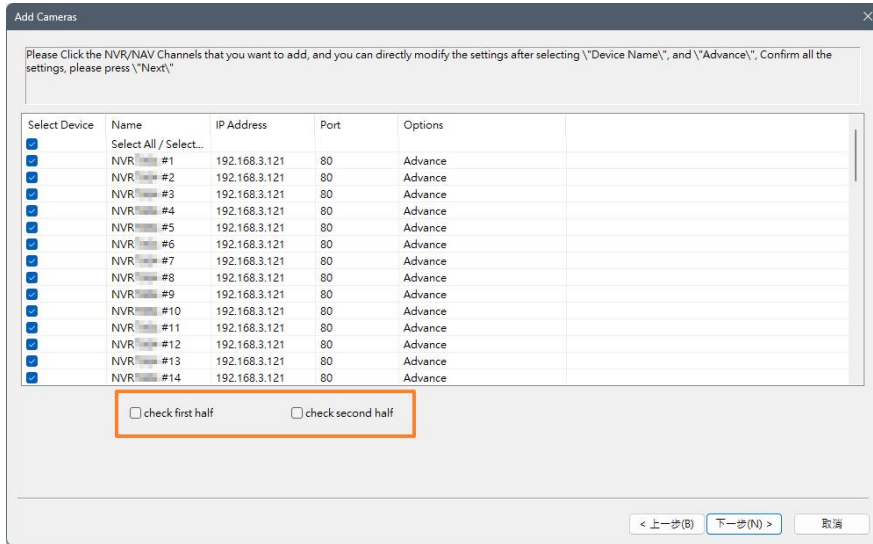

Chapter 8.5 Group Authentication

To assign access rights to particular users, please check Device checkbox to allow access to groups or channels. The default setting allows every user full access to every device in the group. Group access rights also apply to web servers. Users with different access levels can only see the videos of their corresponding groups.

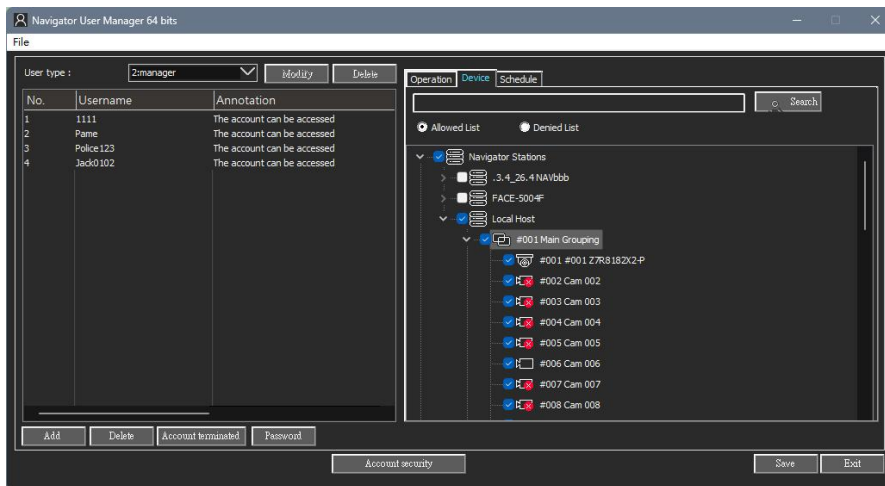

Chapter 8.6 User Authentication

To assign access rights to particular users, please check Operation checkbox to allow access to groups or channels. The default setting allows every user full access to every device in the group. Group access rights also apply to web servers. Users with different access levels can only see the videos of their corresponding groups.

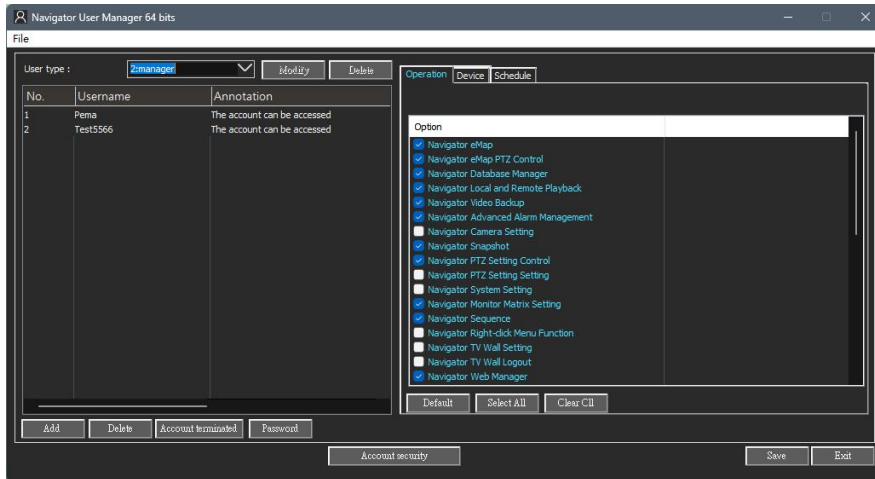

Chapter 8.7 View a Group

To view the videos of a group, click "Groupings" and chose the group you want to see.



Chapter 8.8 Group Sequential Playback

To adjust the group sequential playback interval (seconds), go to the Grouping tab in System Settings.

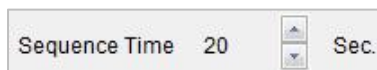

Chapter 8.9 Main Grouping

Main Grouping is a group consisting of 36 devices, which are displayed in a split view in Navigator. To add a device to the main grouping, please follow these steps:

1. Select Main Grouping in grouping dropdown list.
2. Right-click one of the cameras.
3. Select Properties.

Chapter 8.10 Split View

Currently, Navigator supports four types of split views including full screen view, 4-channel view, 16-channel view, and 36-channel view. To open the full screen view, double-click a camera to maximize the screen. Click Windows, and choose the type of view you want to see.

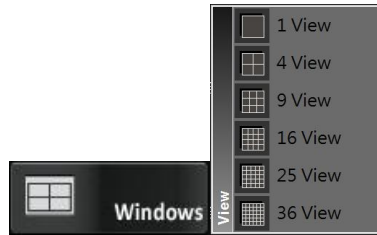

Chapter 8.11 Dynamic Video Channel Swapping

If you want to move a camera channel around, you can simply drag a camera to another video channel. This operation swaps these two cameras' positions dynamically in the software. For users who want to adjust the display position after site installation, they do not need to re-assign the IP settings.

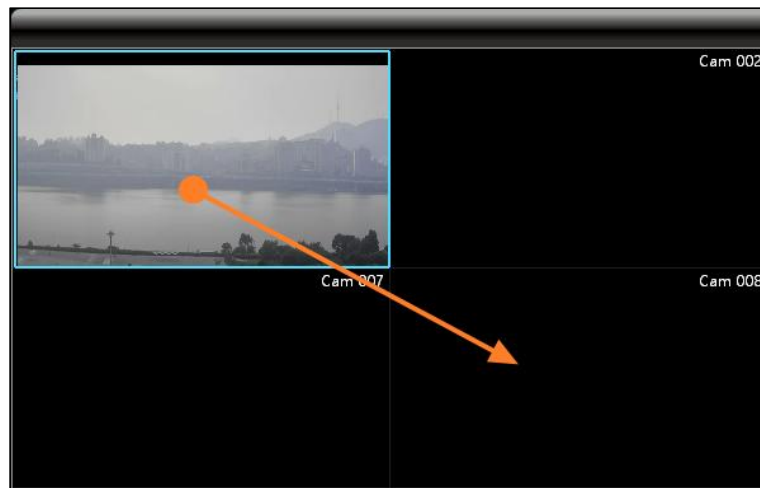

Chapter 8.12 Digital Zoom

To zoom in a specific area, click and drag to create an area for digital zoom. Then you can move the zoom-in area (green area) at will.

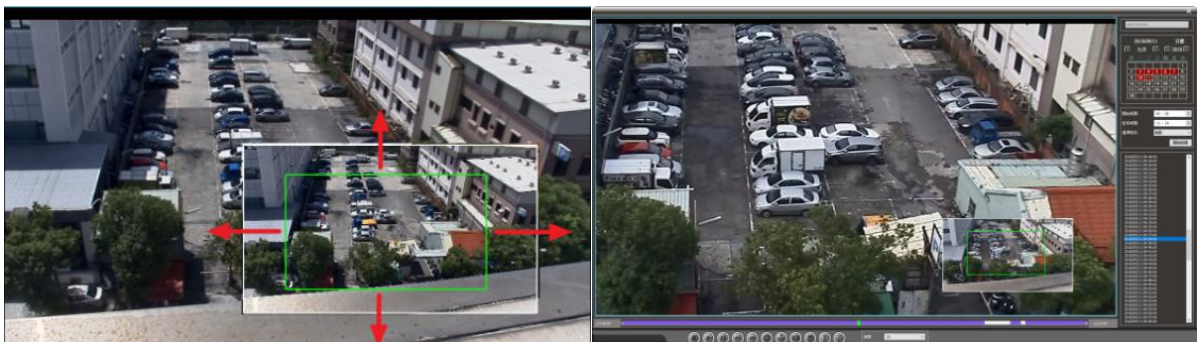

The digital zoom function is also available in the playback mode.

Chapter 9 Playback in Navigator

Navigator can playback the videos recorded by all IP-based products including H.264/H.265 HD IP Cameras, Full D1 IP Cameras, IP Fast Domes, Video Servers, LAN Cameras, and DVRs.

Chapter 9.1 Playback

First of all, select a camera channel or a DVR. Press the Playback icon , and choose Playback . A new window will open.



Chapter 9.2 Playback for an IP Camera Within the Main Grouping

Video recorded in the main grouping can be saved to a local PC. Stored video clips can be played by specified date and time. To do so, follow below steps:

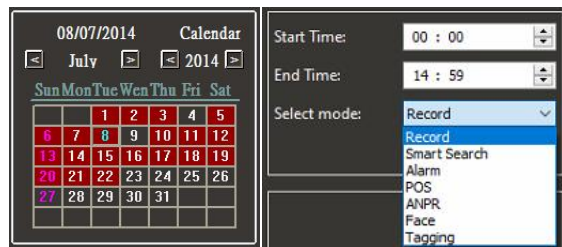

1. Choose a date in the calendar.
2. Specify the starting time and ending time.
3. Click “**Search**” to search the video clips.

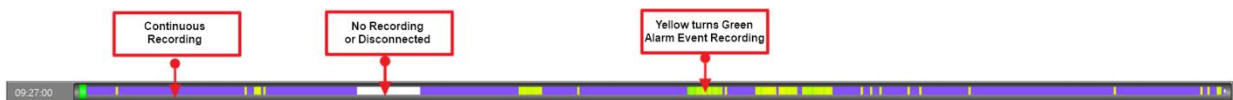

When a video clip is playing, click Stop , Play , Pause , << (Rewind) , >> (Fast Forward) , and Snapshot icons to perform the corresponding function. You can also click the time-bar or drag the scrollbar to jump to a specific time.

- White: No recording or device disconnected.
- Purple: Continuous recording.
- Yellow gradually turns green : Alarm event recording, the color frequency range is 1~10. As events become more frequent, the color gradually becomes greener.

Chapter 9.3 Multi-Channel Playback



You can choose a group for multi-channel playback. Just click the multi-channel playback icon , and a playback window appears as below:

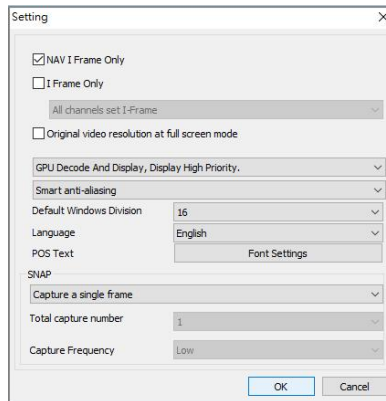

Navigator supports up to 36-channel playback at the same time. A number of settings can be changed for multi-channel playback: (1) NAV/CMX I frame only (2) I frame only. I frame only is only available when multi-channel playback is activated, and activate this option will force Navigator to show only 1 frame/sec in the background to reduce CPU load. For less powerful workstations, we suggest you activate this option. However, you may uncheck the option if CPU usage is low.



Chapter 9.4 Remote Multi-Channel Playback

You may also connect to another Navigator host remotely and play videos saved on that host. To enable remote playback, click Playback, then select Remote Playback . Click the Connect button  and enter IP/DNS address, port number, username, and password to access Navigator. Select a group for multi-channel playback. Moreover, you can add Navigator hosts as bookmarks to instant login in the future.

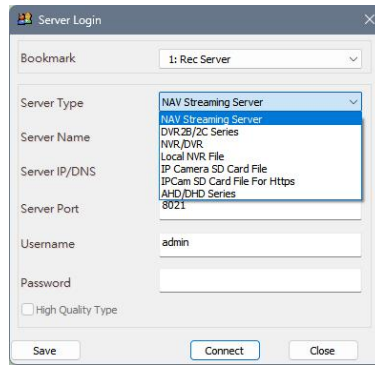

Chapter 9.5 Remote DVR/NVR Playback

For playback videos on a remote DVR/NVR, right-click the DVR/NVR channel and select DVR/NVR Remote Playback.

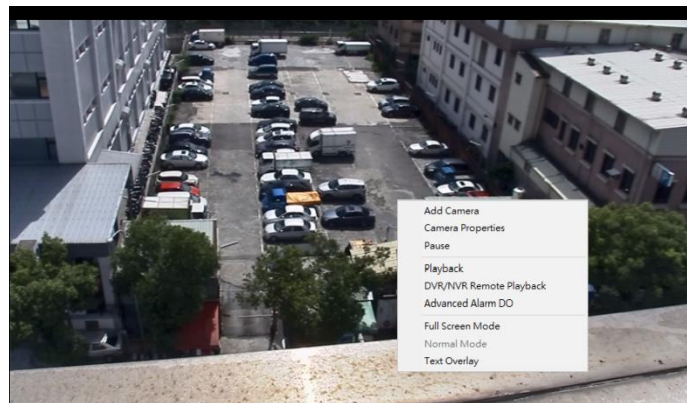

Then you will see the DVR/NVR Playback dialog box. Specify the date and time information in the dialog box to start remote DVR/NVR playback.

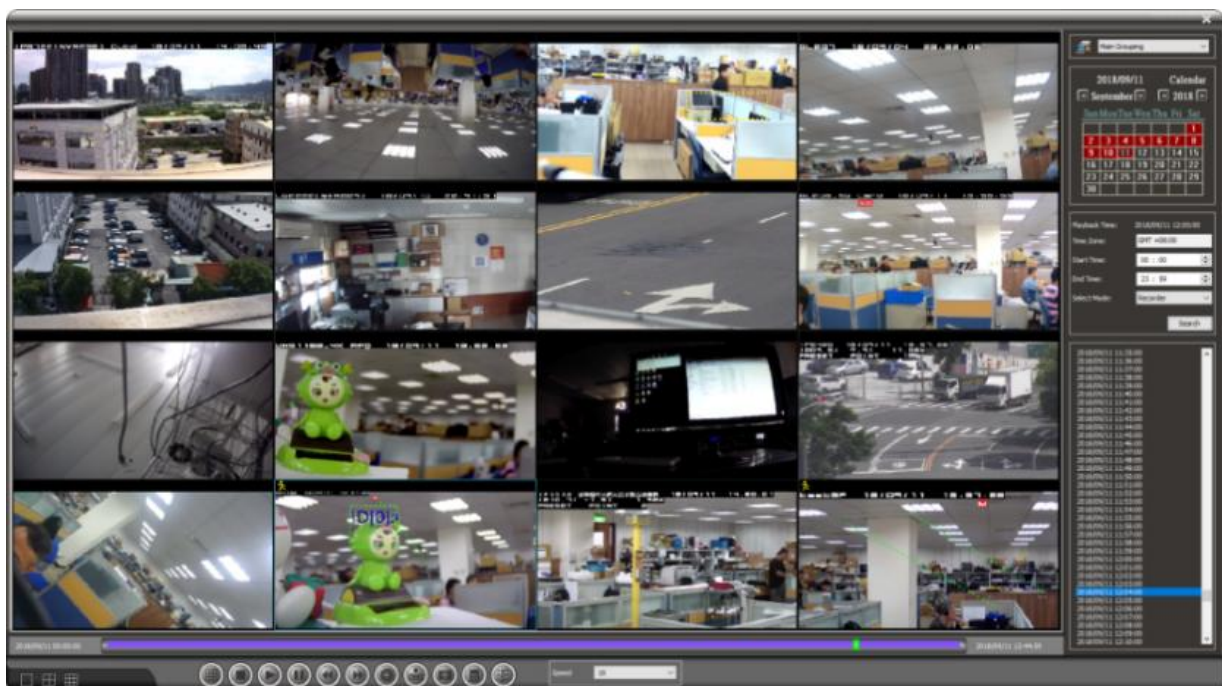

Chapter 9.6 SmartSearch

SmartSearch is available in multi-channel playback. This search function provides quick video search in selected motion detection zones.

To perform SmartSearch, enable full screen mode for a particular camera. Select SmartSearch in the drop-down list of Select Mode and press Search. A SmartSearch dialog box will appear. Drag the motion detection area on the screen inside the SmartSearch dialog box. Click Start, and the system automatically performs a quick scan for any signs of motion activities in the video clip.

In the event list, snapshots of the motion activities will be displayed. Click on the snapshots to jump to the time when a particular event happened.



Then you will see the DVR/NVR Playback dialog box. Specify the date and time information in the dialog box to start remote DVR/NVR playback.

Chapter 9.7 AVI File Export & Play from a File

Chapter 9.7.1 Export AVI with OSD

Users are allowed to export an AVI file recorded by a main grouping device. First you need to open the playback interface and search for a recorded video. Click the Backup button, choose Destination Directory, and press Convert AVI with OSD on the right side of the screen to export the AVI file.

Chapter 9.7.2 Export AVI without OSD

Export an H.264 AVI file without an OSD timestamp can be much faster than rendering an AVI file with a timestamp.

Navigator stores its video clips in a GUID folder inside the default Video folder. The GUID folder is named by a 32-digit hex string. The videos are saved under year, month, day, hour, and minute.

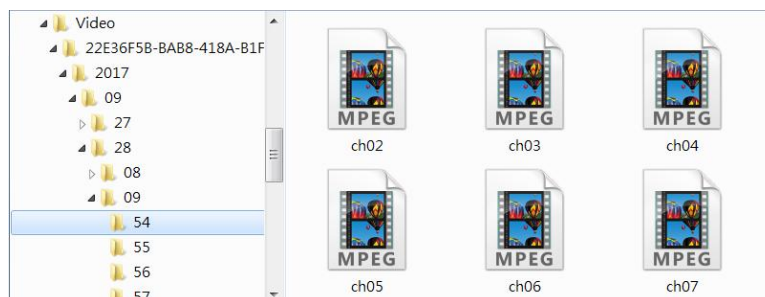

Note: As the OSD file is too large and it takes a long time to backup, OSD backup AVI supports maximum of 1920 x 1080 resolution only.

Chapter 9.8 Multi-Channel Backup

Multi-channel backup features (1) multiple channel playback through MPlayer, which is a comprehensive media player; and (2) AVI backup for multiple channels.

To back up your files, click the Backup icon  and select channels. Specify the date, time, and destination directory. Finally, choose Start Backup or Covert AVI for multi-channel video backup to begin.

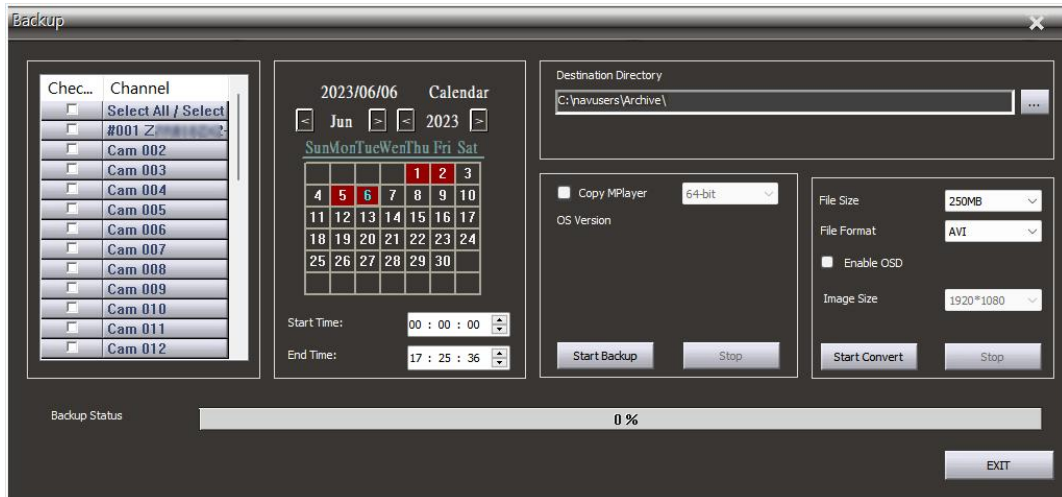

Chapter 9.9 Snapshot

In a system consisting of IP based services, you may want to capture images in a particular video. You can utilize this function in Navigator by simply clicking the Snapshot icon . The picture will be saved as a JPEG file.



Chapter 9.10 Alarm Event Playback

To playback motion detection events, choose Alarm in the Select mode drop-down list, and click Search to display all motion detection events. Click any of the events to play associated videos.

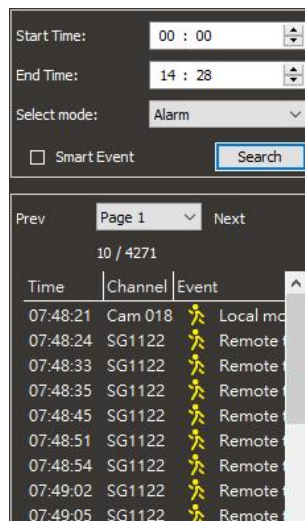

Chapter 9.11 Tagging

To tag important video clips, click “**Tagging**” to tag the video. The tagged time video clip will be retained even when have exceeds recycle recording number of days.

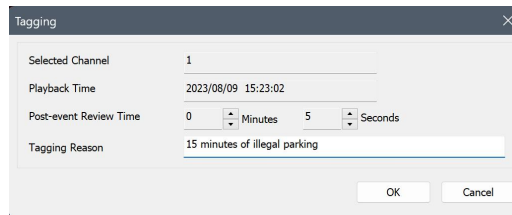

Select “**Tagging**” to playback event and you can playback important clips. If you don't want to occupy recording space, right click → “**Clear**” or “**Clear All**” tagged time in the tag period.

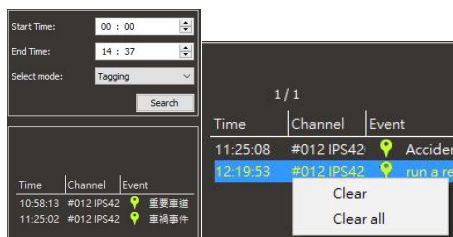

Chapter 10 Audio

Chapter 10.1 Two-way Audio

Navigator supports two-way audio enabled surveillance cameras. To activate this feature, select a particular channel and click the Speaker icon at the top-right corner to listen to the audio of the channel. You can also move the volume bar to adjust the volume. To speak to a remote site, please click the Microphone icon next to the speaker icon.

NOTE: Audio monitoring is only available in the full screen mode. Double-click a channel to enter the full screen mode.

Chapter 10.2 Two-way Audio Auto Switching

Navigator supports two-way audio for IP cameras. Check Audio Auto Switch in Properties will automatically enable audio and microphone feature when the camera is switched back and forth.

Chapter 10.3 Audio Recording

Navigator supports audio recording using IP camera models equipped with audio input. The Playback interface can play audio (if any) simultaneously with the recorded video.

Chapter 11 Archive Manager

Archive Manager, a built-in feature in every copy of Navigator, can archive videos to a central network storage device. Archive Manager delivers a hassle-free experience that automatically saves your video clips to a secure location. To open Archive Manager, please go to Start→ All Programs→Navigator→ Archive Manager.

Chapter 11.1 Archive Source

To start video archiving, select the cameras you want to archive. You can either keep the video clips in the local PC (duplicate archiving), move the local data to a remote archive destination, or stop archiving for a specific time frame. After the configuration is completed, you can schedule the archive task by choosing the hours and days you want the archiving to take place. Also, you can apply all settings to the schedules of other cameras.

Chapter 11.2 Archive Destination

You can choose the Archive Drive where video clips will be archived. The Archive Drive could either be a network RAID drive or an internal SATA RAID for large data storage. To choose a NAS RAID as the archive destination, click Setup Network Disk to mount a remote drive to Navigator. After the disk is chosen, select Real-Time Archiving or Scheduled Archiving. The former will start archiving immediately the next minute, and the latter will start archiving in the designated time.

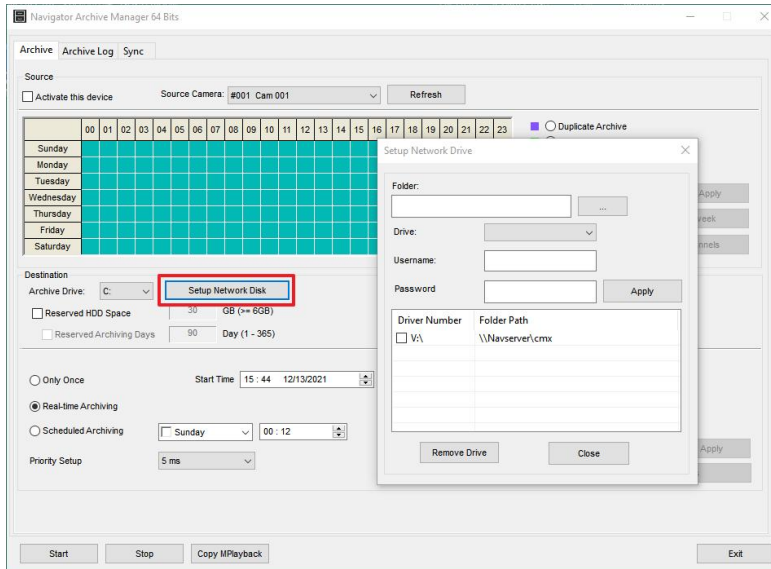

Chapter 11.3 Synchronization

NAV recorded file sync

- **Data overwrite:** The system obtains the image data from the device and overwritten back to the NAV recording host.
- **Data no overwrite:** The system checks for missing video clip but does not overwrite.
- **Data recovery:** The remote server has a storage device in IP Camera SD card. When the network is disconnected, it will recover disconnected portion from the SD card.

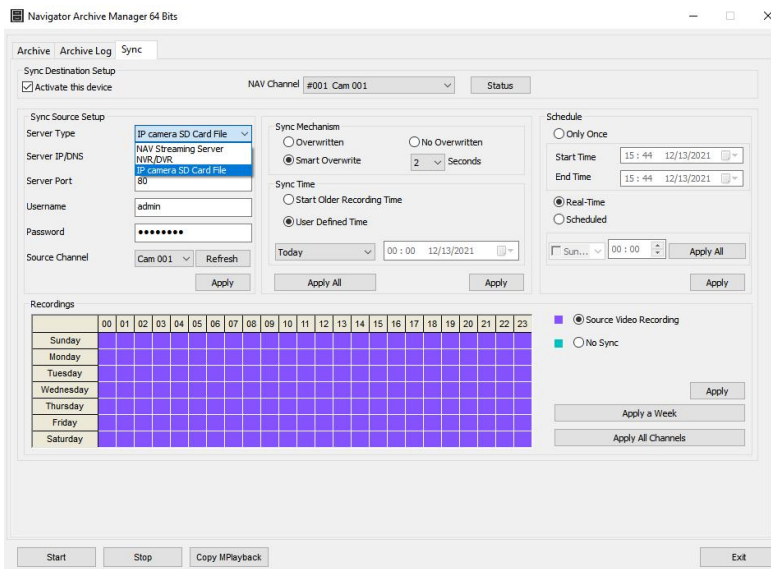

Note: When the device is disconnected, it can also pass through the storage device. For example: IP camera SD card for backup to the Navigator host

Note: Synchronized devices can have up to 1 channel at a time. When the network or remote device is backed up for too long, another channel will be back up after the maximum time of 1 hour is reached, until all channel sequences are completed.

Chapter 11.4 Back up Log

After completing the above steps, you can see the synchronized information in the Archive log.

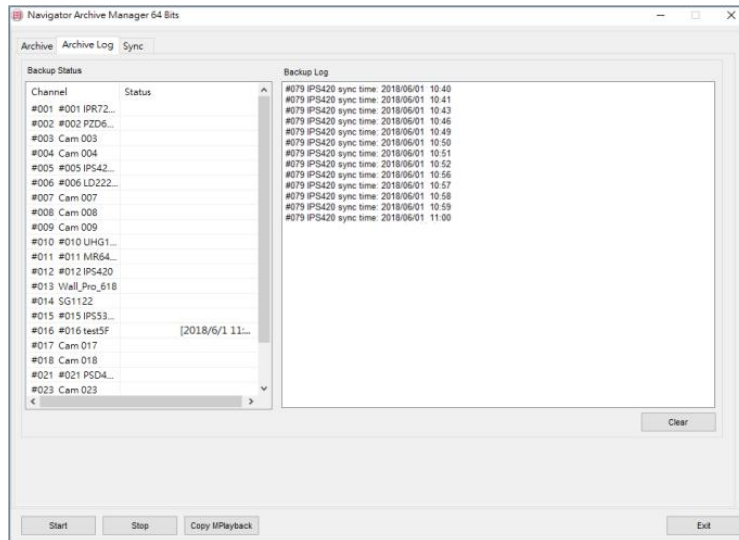

Chapter 12 PTZ Control Panel

In Navigator, you are able to control the movements of PTZ cameras. Select the channel of a PTZ camera (e.g., IP Fast Dome) and click PTZ Setting to control the movements freely using a PC keyboard and/or the PTZ control panel

Chapter 12.1 Preset Point Settings

To set up preset points, please invoke Presets dialog box. Follow the following steps:

1. Select preset point dropdown list.
2. Type the time field.
3. Type the speed field.
4. Click up, down, left, or right to move the IP Fast Dome to specific position.
5. Click Apply button to set the position.

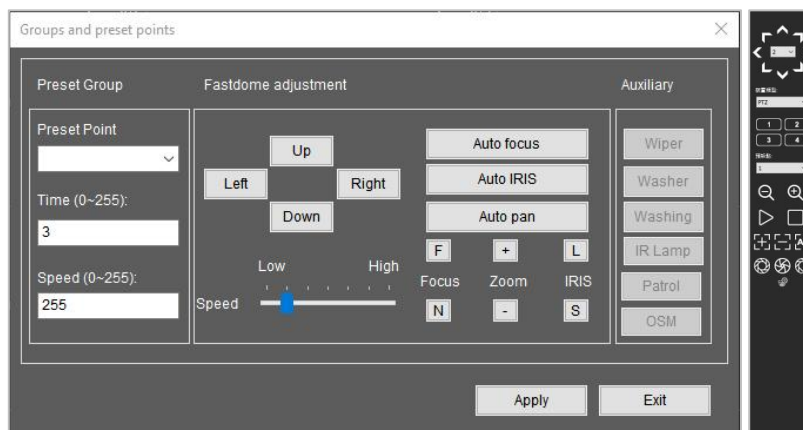

Chapter 12.1.1 PTZ Control Panel Instructions

Icon	Function	Description
	Direction Button	Rotate the PTZ to 8 different directions including up and down, left and right, upper right and lower right, upper left and lower left.
	Moving Speed	Select to adjust the speed of PTZ rotation (up to 7x).
	Device Type	Select supported camera device type, ePTZ, PTZ, auto focus, Fish Eye.
	Preset Recall	Up to 4 preset points can be recall instantly.
	PTZ Preset Point	Up to 128 preset points can be programmed.
	Zoom +/-	Adjust digital zoom in/out.
	PTZ Auto Pan	<input checked="" type="checkbox"/> Enable Auto Pan, <input type="checkbox"/> Disable Auto Pan
	Auto Focus	Manual Focus +/- , Auto Focus AF
	Auto Iris	Manual Iris Far/Near, Auto Iris
	Preset Point Setting	Set auto pan preset positions.

Chapter 12.2 On-screen PTZ Control

In full screen mode, click on  on-screen control icon that can enable PTZ control by using a mouse. Use mouse scroll wheel for PTZ zoom in and zoom out.

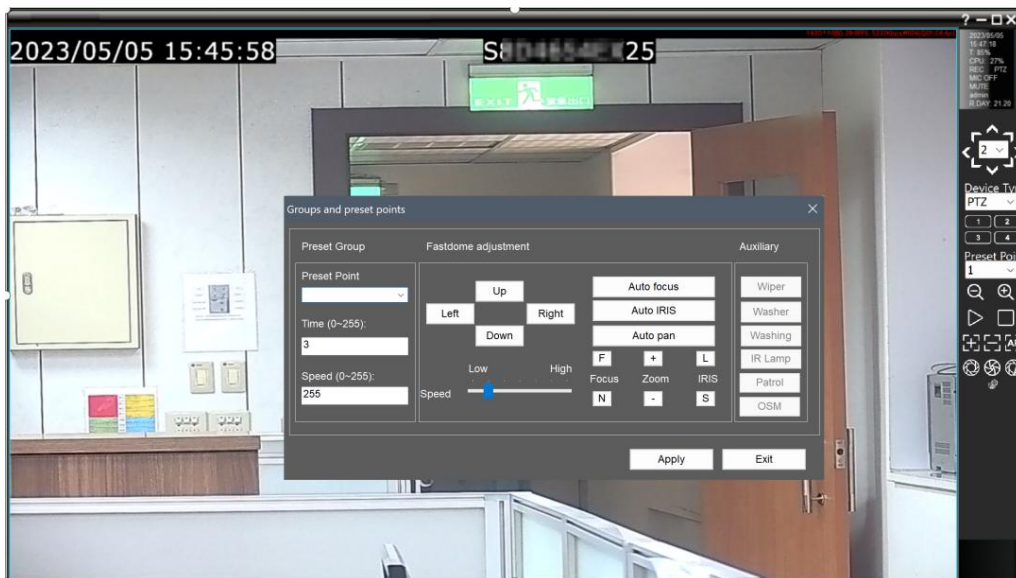

Chapter 12.2.1 Control PTZ via a Mouse

In full-screen mode, click the PTZ control button to control the PTZ on the screen. After enabling the mouse PTZ mode, use the mouse scroll wheel to zoom in and out the PTZ.



Chapter 12.3 On-screen Panoramic Camera Control

In full screen mode, click on  on-screen control icon to enable panoramic camera control by using a mouse. Use mouse scroll wheel for camera zoom in and zoom out.

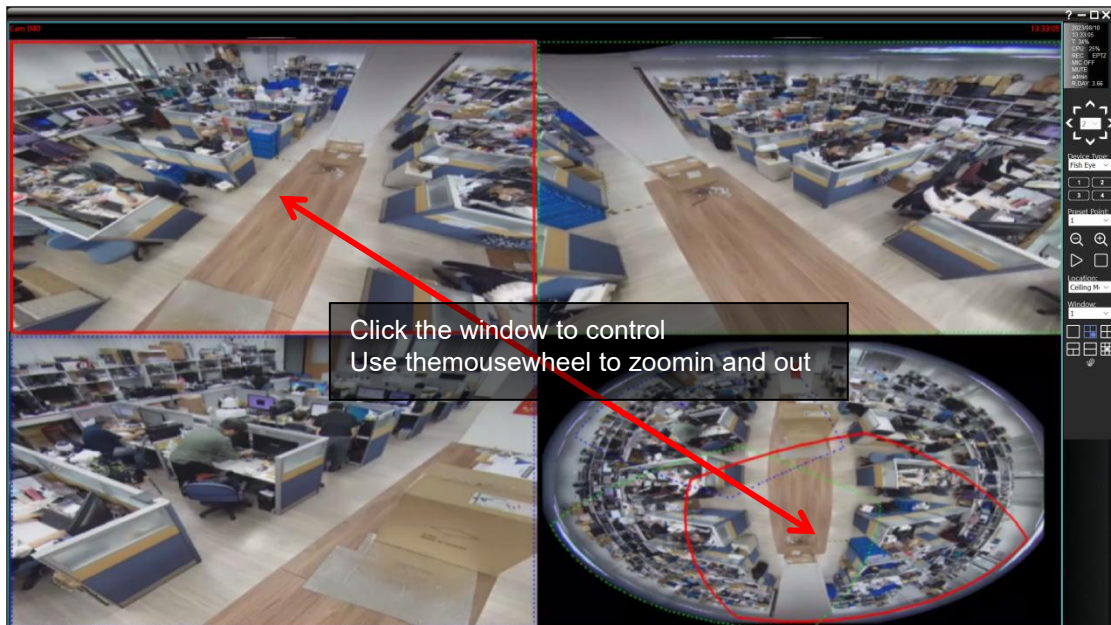

Drag the window at the panoramic view to adjust the ROI window. There are three mount types available - ceiling mount, wall mount, and desk mount.

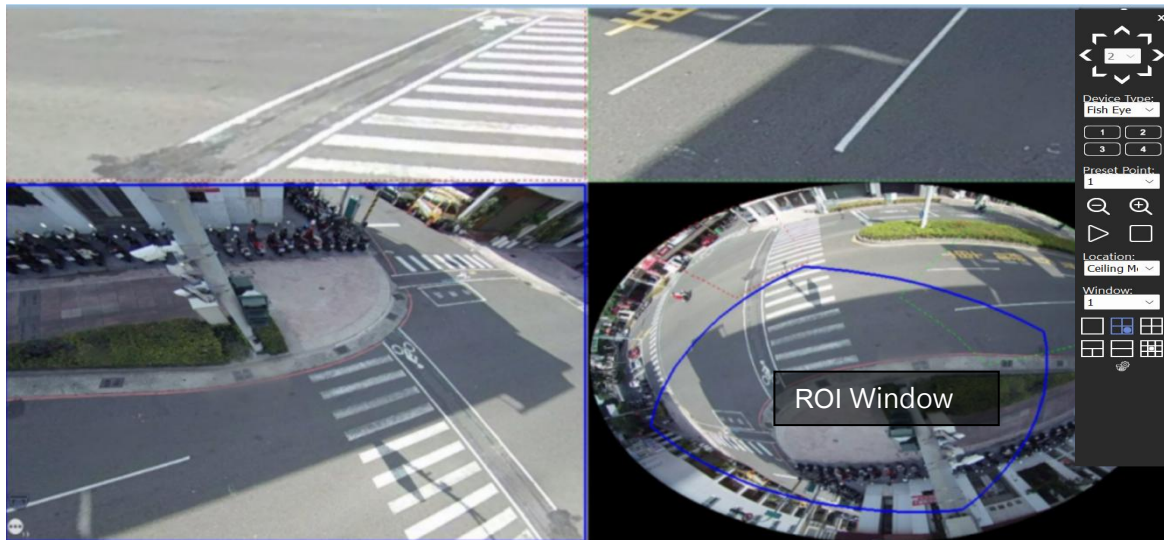

Chapter 12.3.1 Fisheye Control Panel Instructions (Ceiling Mount, Table Mount)

Icon	Function	Description
	Location	Location: Ceiling Mount, Table Mount, Wall Mount
	R Mode	Full-screen panoramic view
	3R1O Mode	Three ROI views and one panoramic view
	4R Mode	Four ROI views
	2R1P Mode	One panoramic view and two ROI views
	2P mode	Two 180 degree views
	8R1O Mode	One panoramic view and eight ROI views
	Preset Point Setting	Provide up to 128 preset points storage.

Chapter 12.3.2 Wall Mount Installation

The wall mount mode is different in some split screens and angles, please refer to the following.

Icon	Function	Description
	2R1P Mode	One 180 degree view and two ROI views
	1WP Mode	One wall mount 180 degree view

Chapter 12.4 Navigator Status Panel

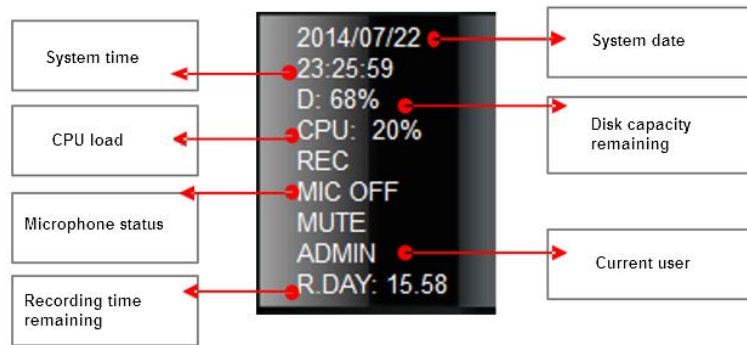

Chapter 12.5 Control PTZ via our 3D Keyboard

Many Navigator functions can be activated with our 3D keyboards. Connect our 3D keyboard to a Navigator host through an RS-232<->RS-485 adapter.

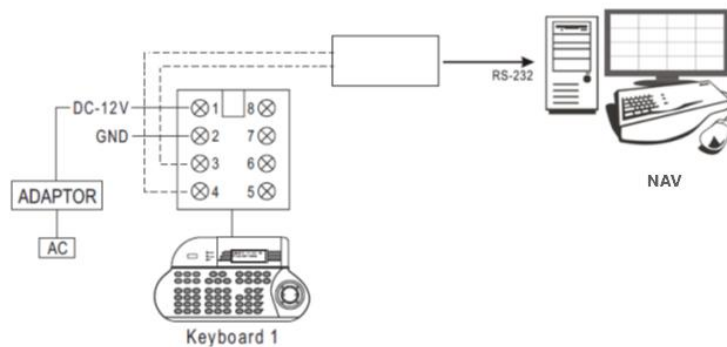

First, enter the DVR/NVR control mode by pressing SHIFT and DVR.



To use Navigator features, simultaneously press Navigator ID, DVR, and ENT.



To select a group, press and hold the monitor ID and MON before pressing the group ID and PRESET.



Chapter 12.6 Split View

To switch split views, launch Navigator and press the following icons:

	16-channel		8-channel	Navigator ID+ DVR+ENT	36-channel
	9-channel		4-channel		

To enter the 36-channel view, simultaneously press the Navigator ID, DVR, and ENT. The operation is the same as operating a Navigator host.

Chapter 12.7 Control a Camera

For control a camera, simultaneously press the camera number and CAM buttons.

Example: Control camera #8



PTZ and Lens control

	Zoom in		Zoom out
	Pan left		Pan right
	Tilt up		Tilt down
	Zoom in		Zoom out
	Focus far		Focus near
	Iris close		Iris open

Chapter 12.8 IP Camera ePTZ or ROI Feature

Several models of IP cameras provide ePTZ or ROI features. With the help of Navigator, you can use a keyboard controller to access ePTZ or ROI feature.

Chapter 12.9 Switch between Navigator and Virtual MatrixMonitors

See Control PTZ via our 3D keyboard to use Navigator features.

Now you can select a monitor for Navigator.



Press button 1 and MON simultaneously to control #5 Navigator monitor.

Chapter 12.10 Keyboard Playback

See Control PTZ via our 3D Keyboard to use Navigator features.

To access multi-channel playback, click the Step Forward icon to enter the playback mode.

To access single-channel playback, click the Play icon .

In Playback Timer Setup, use the joystick to enter date and time. Press ENT button to search through videos.

Press ESC to exit and press ESC again to exit the playback dialog box. Below are the control icons to playback with our 3D keyboard.

Option	Icon	Description
Pause		Pause playback.
Play		Start or continue playback video.
Fast Forward		Fast forward the playback video.
Fast Rewind		Fast rewind the playback video.
Stop		Stop playback and return to playback menu.

Select various split display modes on live and playback monitoring.

Chapter 13 eMap Manager

eMap is an application that can manage devices such as IP camera, IP Fast Dome, and DVRs/NVR on any maps. With eMap, user can easily locate a particular device on a map. Launch eMap Manager in Navigator→eMap Manager.

Chapter 13.1 Access eMap

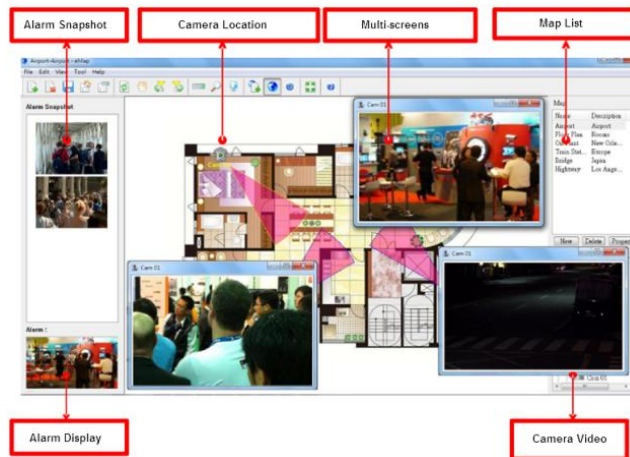

Chapter 13.2 Find Devices

To find a device within eMap Manager, go to View→Find or click the Find Device icon , and a list of found devices appears at the bottom right corner of the screen. Choose any of the found devices.

Chapter 13.3 PTZ Control Panel

To control PTZ device, double-click a PTZ device, and operate PTZ function on the PTZ control panel.



Chapter 13.4 Toolbar

The icons from left to right are described as follows:

Option	Icon	Description
Device list		Display the device list.
Find device		Switch to the Find Device panel.
Refresh		Refresh the map and device information.
PTZ control		Switch to the PTZ control panel.
Edit PTZ control		Supports 4 basic presets.
eMap edit mode		Add or modify devices on the map.
eMap control mode		For PTZ control and live monitoring mode.
eMap alarm switching mode		Switch to the map where an alarm is detected.
Division		Switch to quad screen in eMap Manager mode.

Chapter 13.5 eMap Alarm Options

- Continuous snapshots: the number of continuous snapshots is taken for each alarm.
- Alarm snapshot interval (sec): the time interval between photos to be taken.
- Alarm video output time: triggering interval between alarm detections.
- Number of snapshots stored: the buffer size for storing JPEG snapshots.

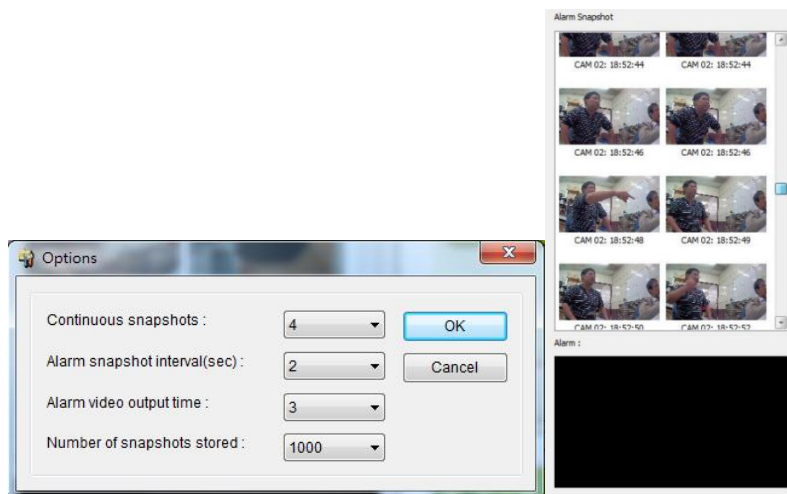

Chapter 13.6 Add a Map

To add a new map, go to File-> Add Map. Or you can press the New button at the top-right corner. Select the JPEG map file representing the installation site and enter map name and location information.

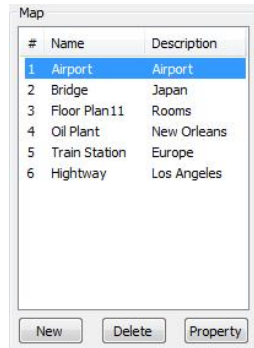

To delete a map, select the map in the Map List, and go to File -> Delete Map or click Delete at the top-right corner.

Click Property to change the name and location of a map.

Chapter 13.7 Add a Device to the Map

To add a device to a map, switch to the eMap edit mode before you drag-and-drop a device from Device List to its associated map. You will see a check next to the name of the added device.

Chapter 13.8 Delete a Device from the Map

To delete a device from the map:

1. Select and right-click the device.
2. Select Delete Device.

Or, uncheck the device in the device list.

Chapter 13.9 Modify a Device

To modify a device, go to Edit→Device Property or right-click a device and choose Device Property. In the popup dialog box, you are allowed to make changes to several configurations, including display color and camera coverage.

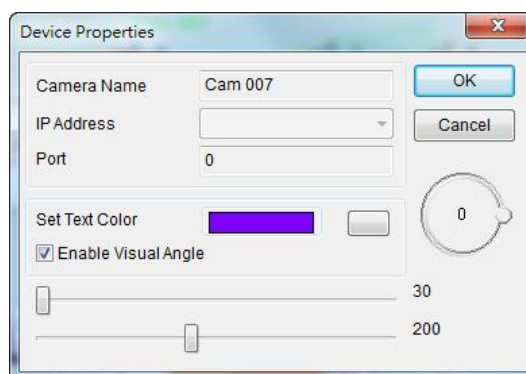

The circular shape on the right of the Device Properties window allows you to control the direction and angle of a camera. Click and rotate the camera view control clockwise/counter-clockwise to change the camera angle and move the two scrollbars at the bottom to adjust camera coverage.

Chapter 13.10 Find a Device

You can easily add DVR, DVR camera, or IP-based devices to different maps. However, finding a particular device for video playback can be difficult and time consuming. eMap Manager provides easy access to any device you want to monitor. Click Find Device , or go to View→Find in the menu bar. A list of all devices in all maps will be shown at the bottom-right corner of eMap Manager. Double-click a device in that list for eMap to automatically switch to the map and show the device as well as its live video.

#	Name	Location
1	Cam 001	Airport
2	Cam 007	Airport
3	Cam 013	Airport
4	Cam 002	Airport
5	Cam 039	Bridge
6	Cam 048	Bridge
7	Cam 053	Bridge

Chapter 13.11 Alarm on eMap

If a motion or digital input alarm sent by Navigator is detected, the camera will start blinking on the associated map, and the live video will be displayed, too.

Chapter 13.12 Quick Map Reference

In the eMap edit mode, drag any map from the list into the map view. This allows quick switching from one map to another by clicking on the map thumbnail.

Chapter 13.13 Alarm Control Mode & Switching Mode

In eMap Manager, it is possible to switch quickly and frequently between maps and videos. A user can manually double-click on the camera icons for its live video. There are up to 4 windows that can be opened at same time. When switching from one map to another, the video window(s) will be closed, and previously opened video(s) will be played automatically in the map that just opens. The feature is very useful if you need to open the maps frequently.

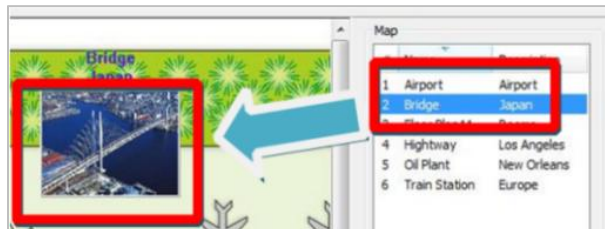

In the alarm switching mode, videos will appear on the associated map while an alarm is received. The videos will be shown in a pop-up window to attract your attention.



Chapter 14 Web Server

Navigator can work as a web server to stream live video. To enable the service, go to System Settings→Network and enter the HTTP port you want to use.

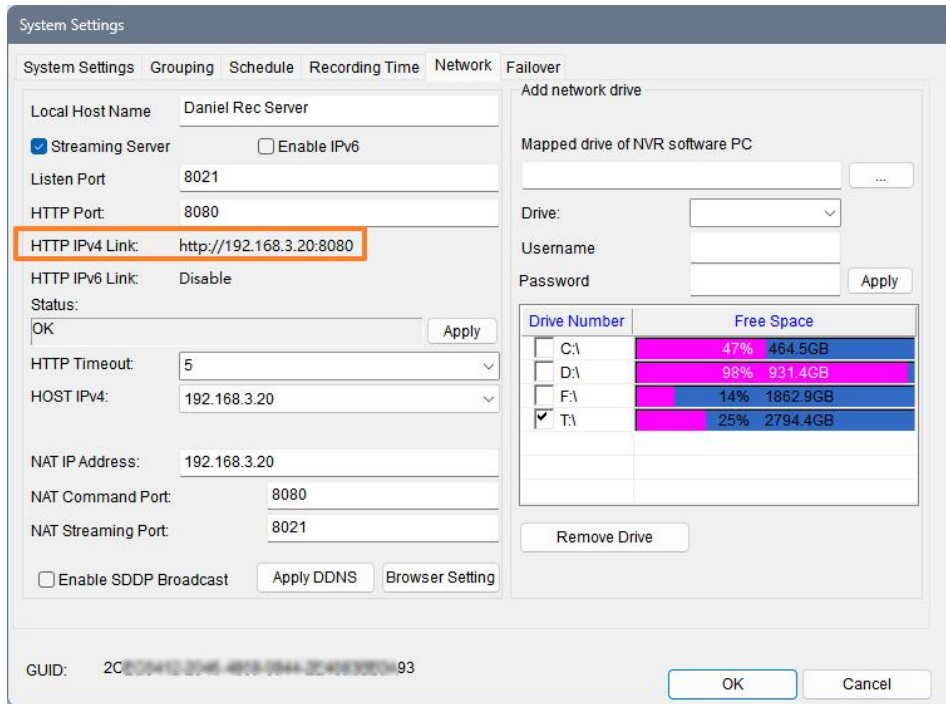

Then, you may either click JAVA 8080 HTTP web connection mode or copy the link to the address bar of your Internet browser to view the video.

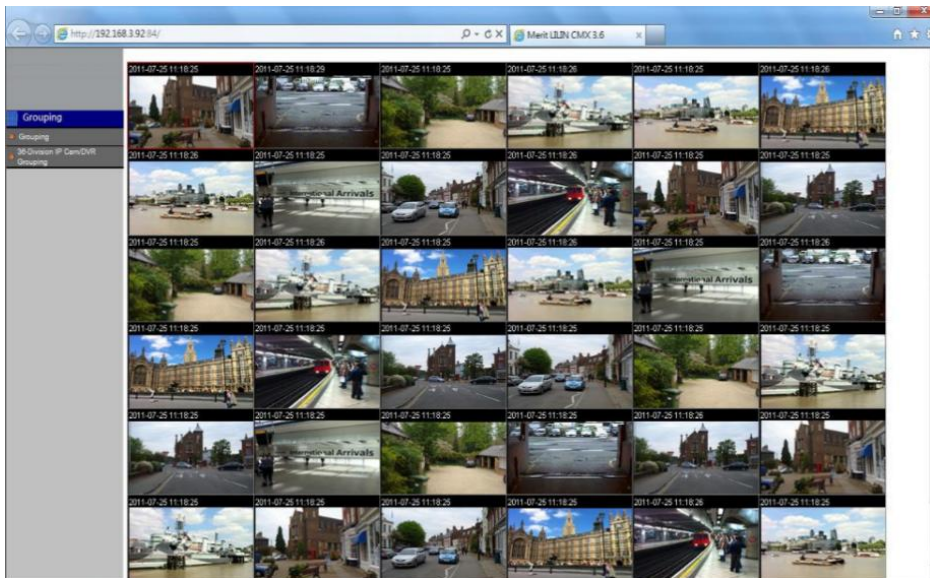

- Note:**
- 1) HTTP streaming may require username and password.
 - 2) Only support IExplore web page.
 - 3) The Win10 8080 Port java webpage has been eliminated, and this function is no longer maintained.

Chapter 14.1 8021 OCX Web Page Browsing Connection Mode

The OCX web page default is Port 8021, you can also connect and view it through a web browser from other locations within the local network.

For first-time users, the ActiveX must be installed, simply follow the instructions and proceed with the installation by clicking on "Next."

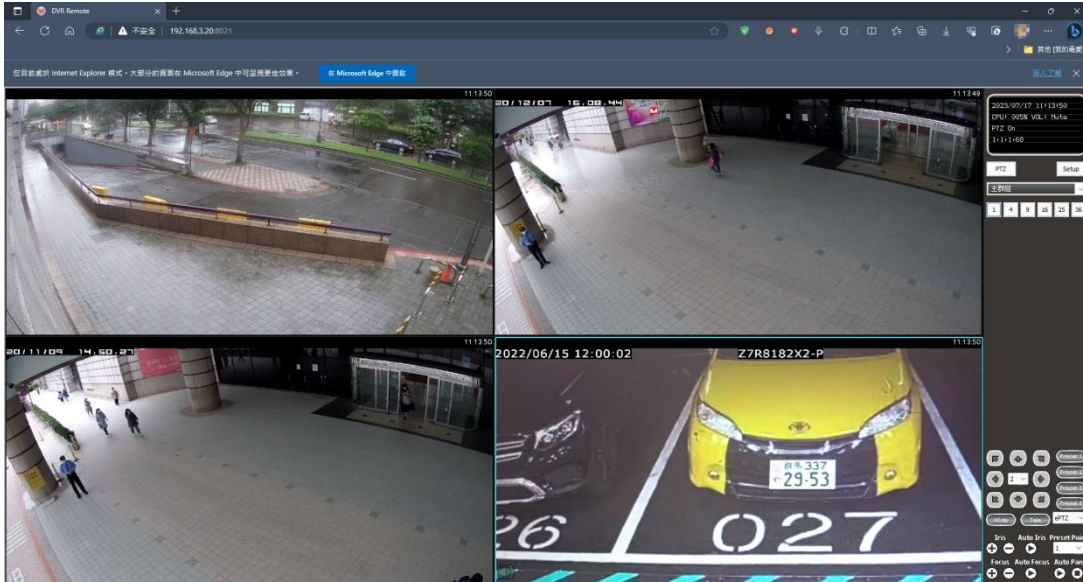

Chapter 14.2 Edge Enables IE Compatibility Mode

The OCX component originally only supported IE mode, but now the new Edge browser also enables compatibility mode. However, you need to access the advanced settings to enable it. If you do not configure the compatibility mode in advance, then you will only see a black screen without any prompt to install the ActiveX component.

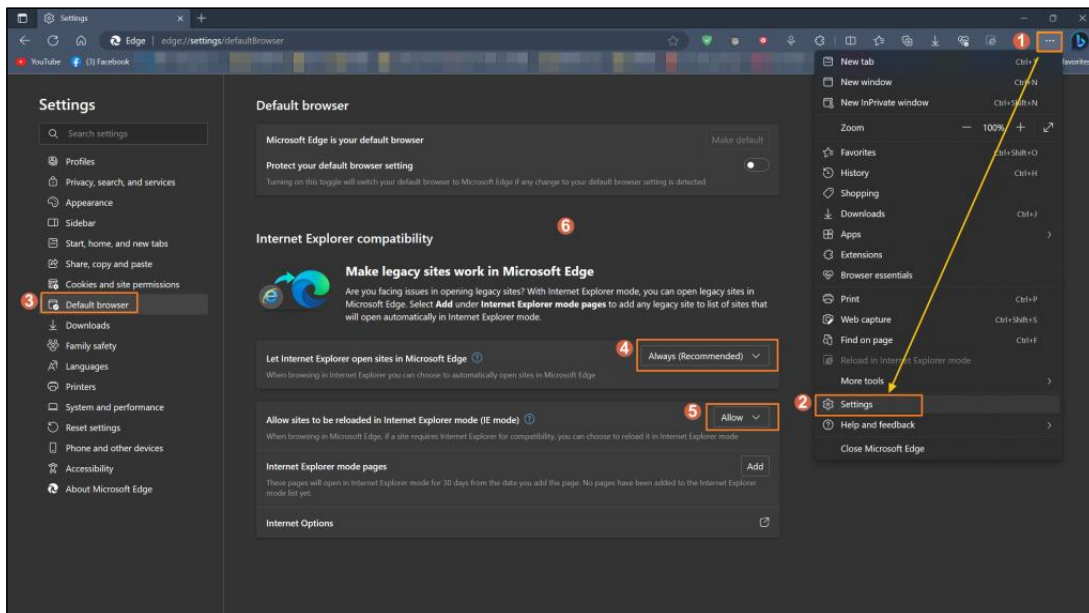

Chapter 14.3 NAT Port Setting

When the Navigate LAN server IP wants to share the connection of the external NCC central control network server, it needs to be forwarded through the NAT port before it can be opened to external connections.

- NAT IP Address: The host IP address
- NAT Command Port: The host shares the HTTP port externally
- NAT Streaming Port: The host shares the monitoring port externally

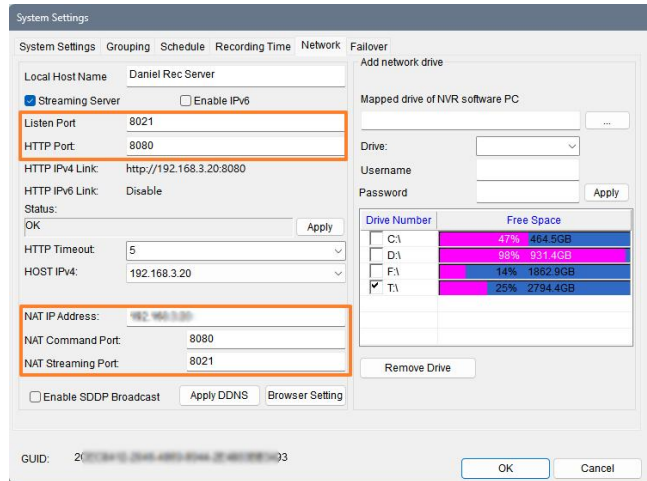

Chapter 14.4 Apply for a DDNS Account

Click on **System Settings->Apply DDNS** -> Enter the Account and Password, and then click on **Register**. To log in to the DDNS account on the mobile device and connect to NAV, please click on **Verify**. The cloud will verify the DDNS registration record of the mobile device, and then you can use the PNS2.0 push notification function.

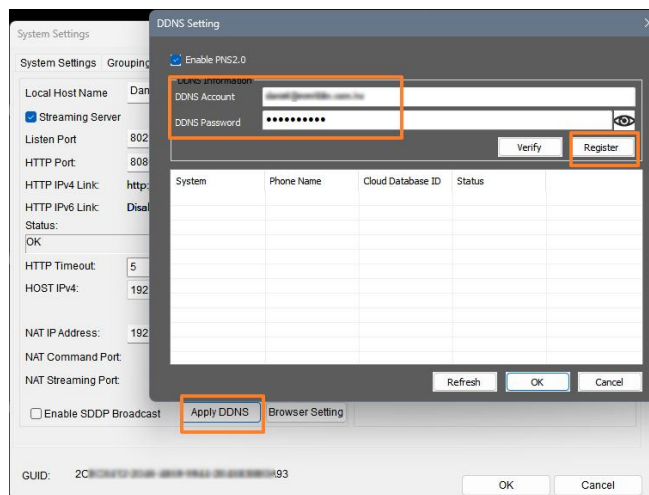

Chapter 15 Database Manager

Database Manager can generate user log report and event report. In addition, this built-in feature allows database import, export, and repair.

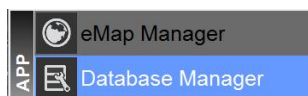

#	Date/Time	User	Operation
1	2017/06/27 17:01:12	admin	Live reconnect on <MAC:00-0F-FC-12-5B-B5> [#026 MR2922A]
2	2017/06/27 17:00:27	admin	Connect Failed <MAC:00-0F-FC-12-5B-B5> [#026 MR2922A]
3	2017/06/27 16:59:58	admin	Live reconnect on <MAC:00-0F-FC-12-5B-B5> [#026 MR2922A]
4	2017/06/27 16:59:13	admin	Connect Failed <MAC:00-0F-FC-12-5B-B5> [#026 MR2922A]
5	2017/06/27 16:58:44	admin	Live reconnect on <MAC:00-0F-FC-12-5B-B5> [#026 MR2922A]
6	2017/06/27 16:57:59	admin	Connect Failed <MAC:00-0F-FC-12-5B-B5> [#026 MR2922A]
7	2017/06/27 16:57:30	admin	Live reconnect on <MAC:00-0F-FC-12-5B-B5> [#026 MR2922A]
8	2017/06/27 16:56:45	admin	Connect Failed <MAC:00-0F-FC-12-5B-B5> [#026 MR2922A]

Item	Icon	Function Description
User Log Report		Click User Log Report to show a complete user log. Press File→Export Log to export a CSV log file.
EventReport		Click Event Report to show a complete event report. Press File→Export Log to export a CSV log file.
POS Event Report		Click POS Event Report to show the full POS record. Press "Export Log" to export the CSV log file.
ANPR Event Report		Click ANPR Event Report to show the complete license plate record. Press Export Log to export the CSV log file.
AI Recognition Log Report		Click "AI Recognition Log Report" to display the complete AI license plate record. Click "Export logs report" to export CSV log file.
Object Counting Report		Click Object Counting Report to show the full object counting record. Press Export Log to export the CSV log file.
TAG Report		Click on Tag Report to show full tag record. Press Export Log to export the CSV log file.
NAV Status		Click NAV Status to show the complete NAV host status record. Press Export Log to export the CSV log file.
GPS Report		Click GPS report to show the complete satellite positioning record. Press Export Log to export the CSV log file.
Face Report		Click Face Report to show the full face recognition record. Press Export Log to export the CSV log file.
Server Report		Click on Server Report to show the full server log record. Press Export Log to export the CSV log file.
Import Database		XML format database can be imported into Database Manager. Click Import Database and choose the database you want to import.
Export Database		Database Manager supports database export to XML format files. Click Import DB and choose the database you want to import.
Export Log		Various event transfer report.
Statistics		Click on Statistics Chart and the object counting record will be converted to chart mode.
Refresh Database		Click Refresh Database to refresh the new event message.

Search Settings		Customizable search events
-----------------	--	----------------------------

Chapter 15.1 AI Export to IVS Simple Chart

AI recognition database can be easily exported, including object type, object color, countries, automobile brands, license plate background colors, behaviors, etc., for IVS statistical charts.

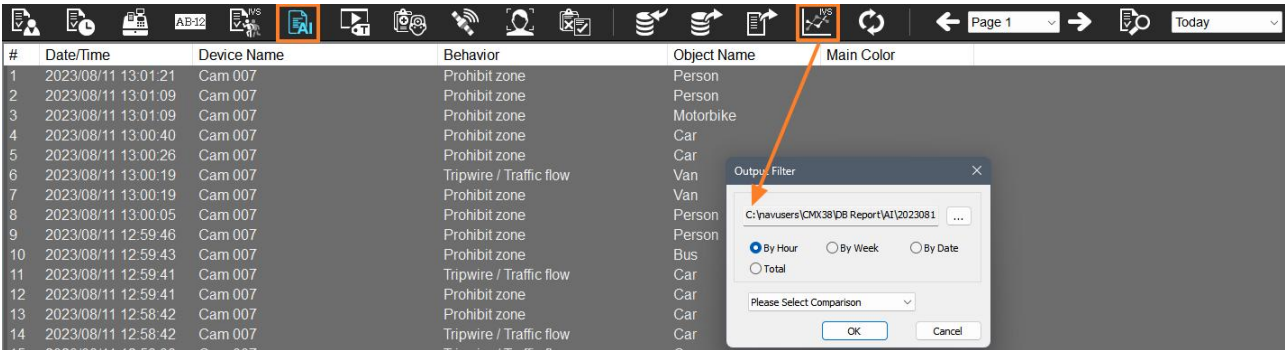

Chapter 16 Multiple Monitors

Multiple monitors support is a native feature in Windows 7 or higher. This feature allows you to view different applications of Navigator on separate monitors.

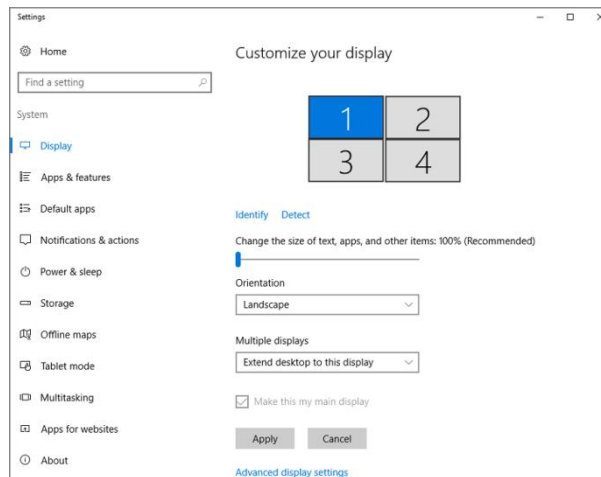

- Note:**
1. NVIDIA standard two graphics cards support up to 4 outputs (Attention! The more channels, the more CPU resources are consumed)
 2. The latest Windows 10 version 21H2 and the new graphics card driver can support up to 6 outputs. For more information, please contact the original manufacturer technical support.
 3. When there is an external NVIDIA graphics card and the motherboard has Intel built-in graphics card, it is recommended not to mix the screen output, and use the external graphics card as the main.

Chapter 16.1 Navigator Multi-Screen Matrix Output

The Navigator can support up to four screen outputs, including one main monitor and three sub-monitors. Once the display card is properly installed, click on **“Multi-monitor output”** to display all connected and detected screens.

Once all the screens are properly connected, please click **"Identify Monitor"** to display the respective number on each screen.



The multi-screen output function is detailed below

- Quad display: Navigator can squeeze four 36 channel views into one large LCD screen
- Default group: the group to be shown on the main monitor.
- Default window division: the default number of split views.
- Auto minimize division: auto minimize division.
- Low CPU usage mode: enable I frame to reduce CPU load
- Alarm Ack Monitor: Customize to display alarm acknowledgment main monitor or sub-monitor.

Chapter 16.2 Alarm Acknowledgement

You can cancel the alarm acknowledgement on any screen that displays an alarm image. Before you manage the camera, you must first click confirm to clear an alarm.



Note: To enable the acknowledgement function, click **Alarm ACK** in the alarm output management list.

Chapter 16.3 Notify Navigator on Another Computer

Third-party software can enable or disable videos on the alarm acknowledgement monitor using the CGI commands provided by Navigator. See HTTPAPI.PDF on our website for more details

Chapter 16.4 Navigator Software 2x2 Video Wall

Four of the six monitors supported by Navigator can form a 2x2 video wall.

Go to Control Panel→Display→Screen Resolution to combine four 1920*1080 monitors to create a 3840*2160 resolution video wall.

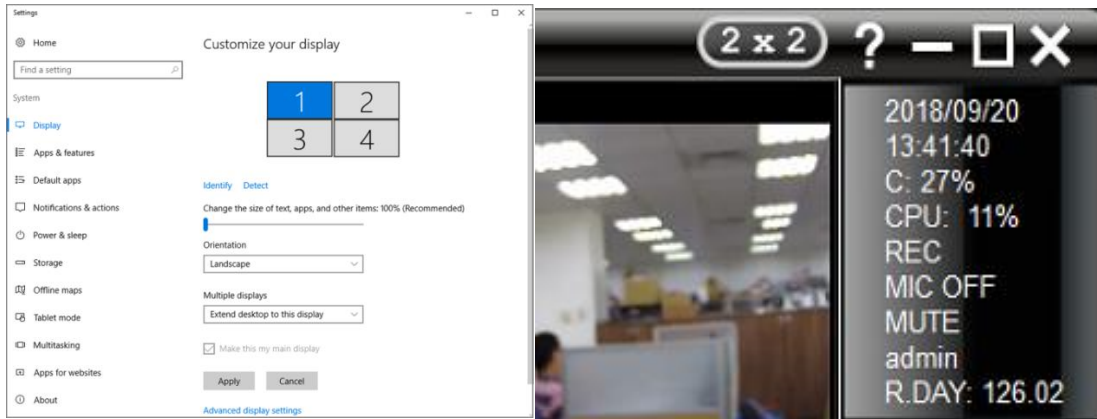

After you finish with the settings, a 2x2 icon will appear at the top-right corner of Navigator, which supports three windows consisting of thirty-six split views and one eMap view.

Note: The Windows main screen display must be set in the upper left corner to properly display the 2X2 position

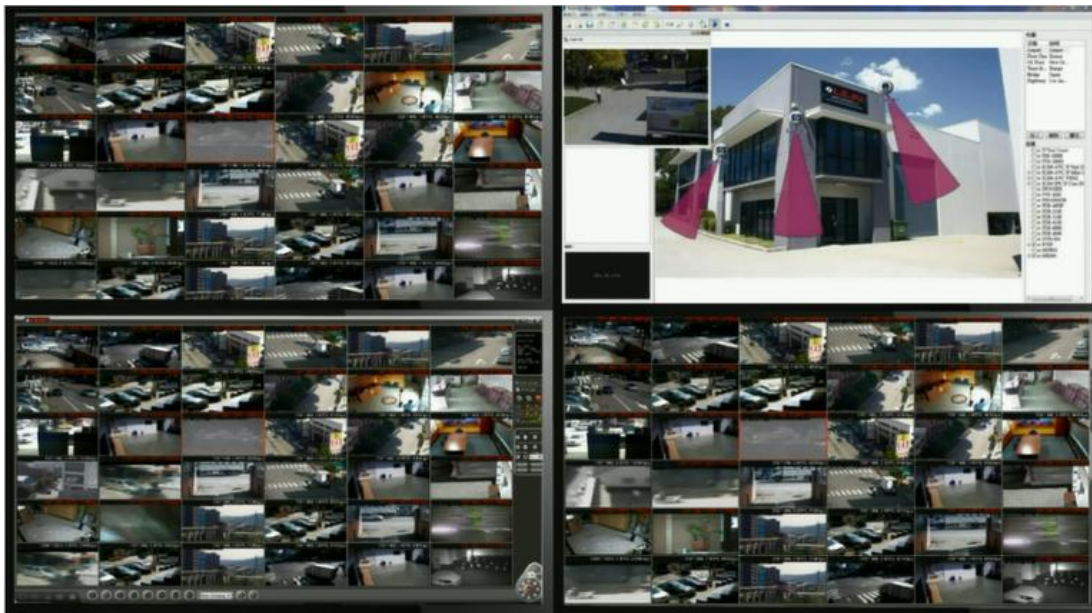

Chapter 17 Retail and Distribution Business Solutions

When connecting to a Point of Sale (POS) terminal ready, Navigator can retrieve POS transaction data, which will be displayed on live video and video playback. Navigator also provides smart transaction search for specific video clips.

Chapter 17.1 Retail POS Application

Navigator listens to the ASCII output of a POS system via an RS-232/COM serial port. Check if your POS LCD or printer is compatible with ASCII or printer output for ASCII data of your POS system. Consult your POS provider for more details.

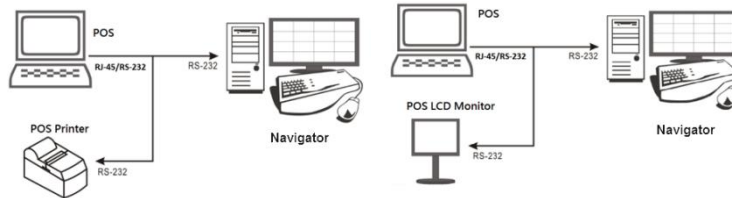

Please refer to the figure below to connect RS-232 RX/TX wires, a POS register/terminal, and Navigator host.

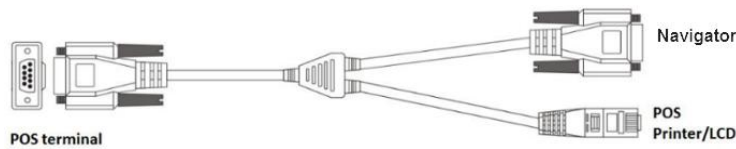

To connect more than one POS terminals, add more RS-232/COM ports into the Navigator host.

Chapter 17.2 POS Connection via TCP/IP for Retail Business

Navigator can connect to an RS-232 POS system through the network using a CYT-100SC RS-232 to TCP/IP converter. The driver disk enclosed in the box of CYT-100SC provides a RS-232 to TCP/IP conversion driver that allows you to establish a virtual COM port on a Windows-based PC. The virtual COM port can be adopted by Navigator to communicate with the POS system.

Chapter 17.3 POS system and Navigator Connection Test

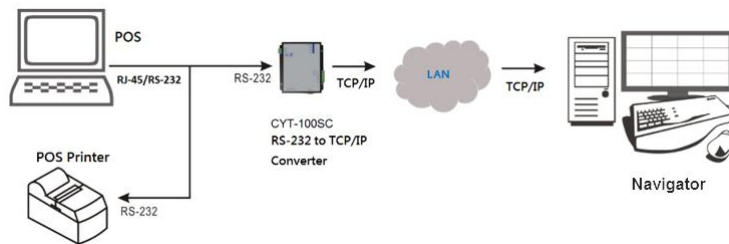

After establishing the connection between the POS system and the Navigator host, please use HyperTerminal or other applications with the same function to test and verify whether the Navigator can capture the POS data

After the connection between the POS system and the Navigator host is established, use HyperTerminal or other alternative applications to test and verify whether the POS data can be captured by Navigator.



Chapter 17.4 Link POS to a Camera Channel

To link a POS system to a camera channel, click Properties and choose ePOS/OSD to open the POS Setting dialog box.

In POS Setting, please specify the following information to capture POS transactions.

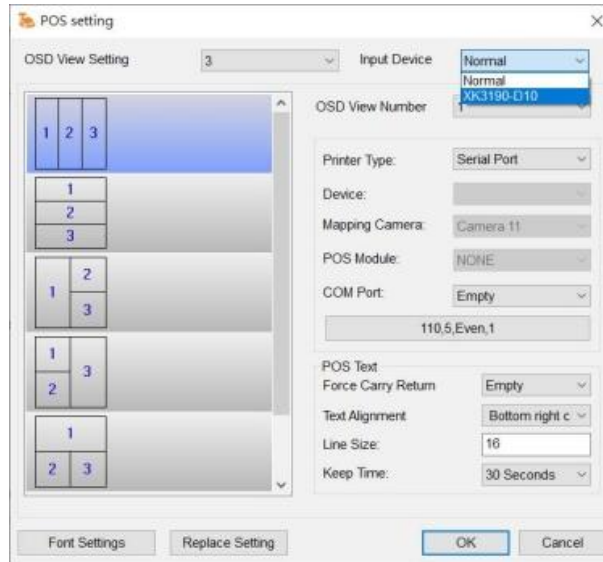

- OSD View Setting: the setting can arrange the POS OSD (text) on top of the camera.
- Force Carry Return: For some of the POS printers, these printers might output 80 characters without carry return. Force Carry Return setting is to force carry return into NAV recorder.

Once the above information is set correctly, Navigator will capture and display POS transactions on live video.



Chapter 17.4.1 POS Replace Setting

Replace setting is to replace the captured POS text, see picture below:

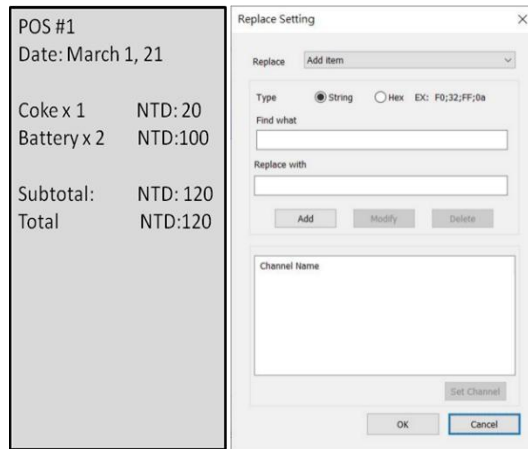

- String: The setting is to replace the captured “POS#1” wording from the POS machine with “My Camera”. A user can enter “POS#1” in the “Find what” field and enter “My Camera” into the “Replace with” field.
- Hex: The setting is to replace the captured POS hex token from the POS machine. For EPSON printer, the ASCII: LF (oct) and hex (0A) is the carry return for the printer. A user can filter out the token “0A” in the “Find what” field and enter “”(space) into the “Replace with” field.

Chapter 17.5 POS Transaction Playback

Navigator supports video playback with associated onscreen transaction data. When you choose a POS transaction entry of any time, the video clip of that transaction will be played from that time.

Chapter 17.6 Search POS Transactions

To search a particular transaction entry such as amount of product, product name, subtotal, or total, you can enter search keywords in the Condition search box. Transactions containing the keyword will be displayed on the screen. You can click any of the search items to playback the videos.

Chapter 17.7 Scanner Connection for Logistic Business

Barcode scanners are widely used in logistic business. When connected to a PC via a PS/2 connector, this device works as an input tool that reads numbers of 0–9 and sends the information to Navigator.

To use a barcode scanner in the transaction process, connect the scanner to the PS/2 port on your PC and choose Barcode Scanner in POS Setting. Information read by the scanner will be sent to this camera. Only one barcode scanner can be connected to one PC.

To search for data corresponding to the barcode scanner, refer to POS Transaction Playback and Search POS Transactions for more details.

Chapter 18 Mobile Device Support

To meet your mobile surveillance requirement, we provide a mobile version of Navigator that supports iOS and Android devices. You can download IPVideo in App Store or Google Play for your iPhone, iPad, and other Android devices. (Please refer to the user manual on your mobile device for more information.)



Chapter 19 Navigator Software Streaming Client & Server

Navigator's built-in software server allows video streaming to Navigator clients. Live streaming to clients may reduce CPU load of the IP camera.



Chapter 19.1 Navigator Streaming Server

To enable the streaming function of Navigator, you may either check Streaming Server in the Network tab in System Settings and specify the port number therein, or go to Start→All Programs→Navigator→Streaming Server.

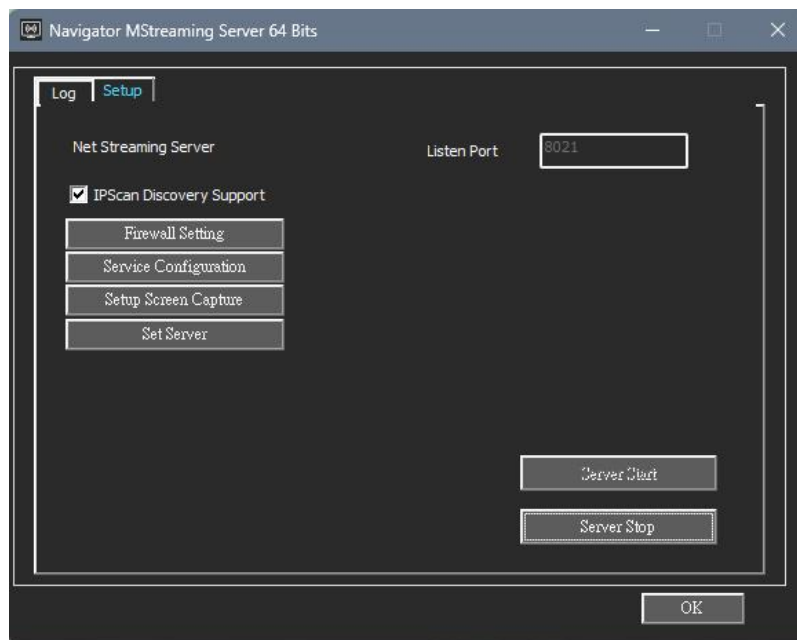

Note: Do not turn off streaming server if you want to perform live streaming.

Chapter 19.2 Navigator Software Streaming Client

To connect to a Navigator live streaming server as client, click Properties and select Navigator Live Streaming from the drop-down list in Device Type. Then, enter the IP address and port number of the Navigator streaming server.

Chapter 19.2.1 Navigator Firewall Mode Setting

When the Navigator MStreaming Server opens the port, the user can add or modify the black and white list to block the connection of the device outside the specified IP or IP location range, which can improve the server's security and loading.

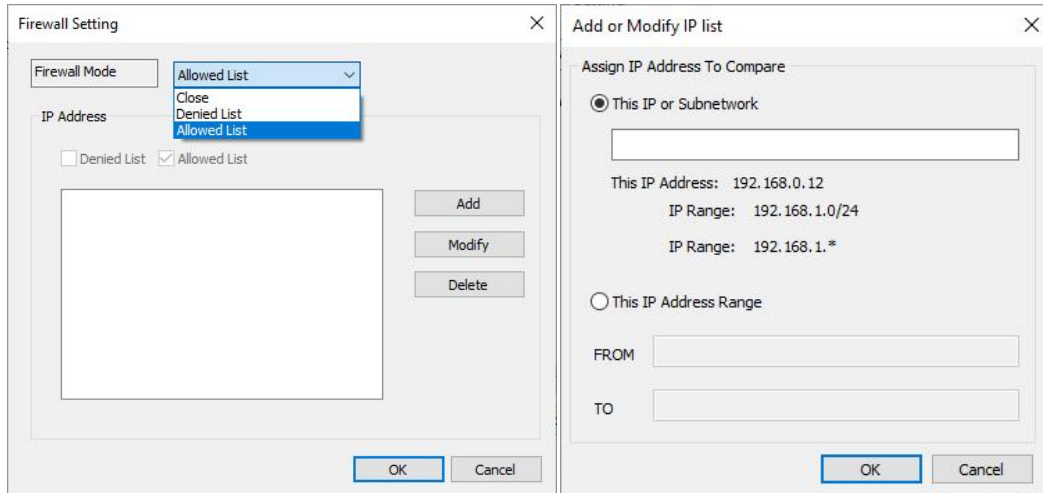

Chapter 19.2.2 Navigator Navigator Service Settings

By using the tree diagram management, the host can connect to more than 4,000 NAV recording hosts at the same time, and manage more than 60,000 various connected devices. Through the internal network or INTERNET connection, real-time monitoring, management, setting and information storage of the remote NAV recording host can be performed through simple settings. And it can live display and analyze NAV recording host and equipment real-time image, video data, running status, operation information and various alarm IO/GPS/POS/license plate information.

Make sure that each NAV host has our Navigator and Control Center installed.

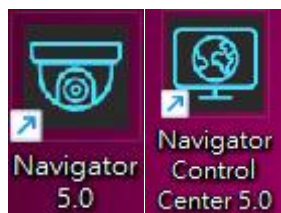

Please click on the icon at the bottom right of the computer toolbar, then mouse left click on Streaming Server 64 bits.

1. In the lower right of the computer toolbar, click on **Streaming Server 64 bit** and then left click on it.
2. Click on **Settings** and click on **Service Configuration**

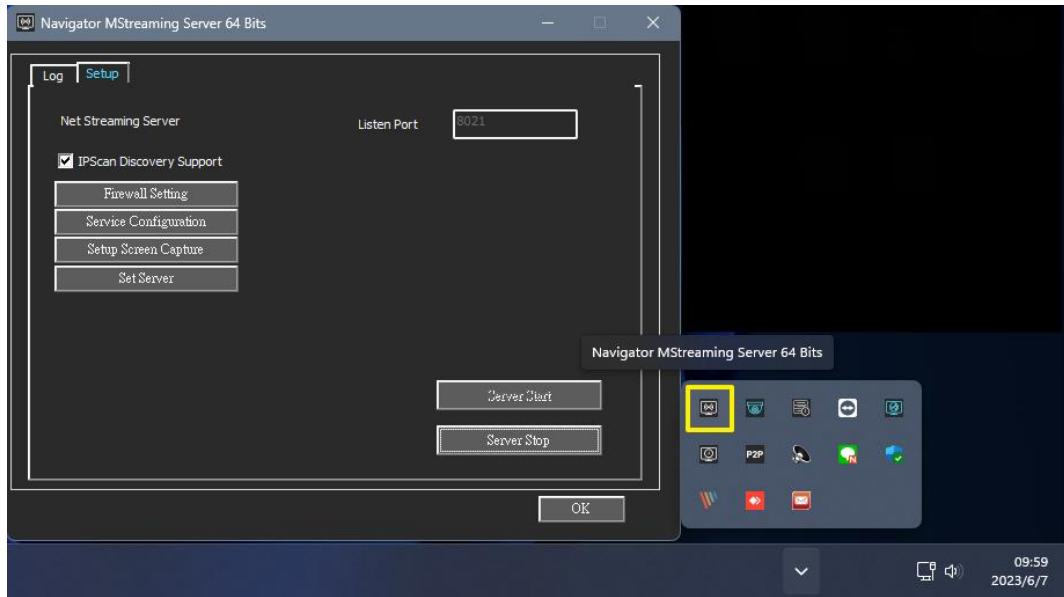

3. Check Enable Navigator Control Center
4. Select Server 「Control Center Service」.
5. Select Service Type: Navigator Control Center service
6. Create Chinese/English Verification Code and Service Code
7. Click on Setting

"Easy Mode" is checked by default, and the verification code and service code are skipped. Just login the account and password, to connect to the central control tree diagram device.

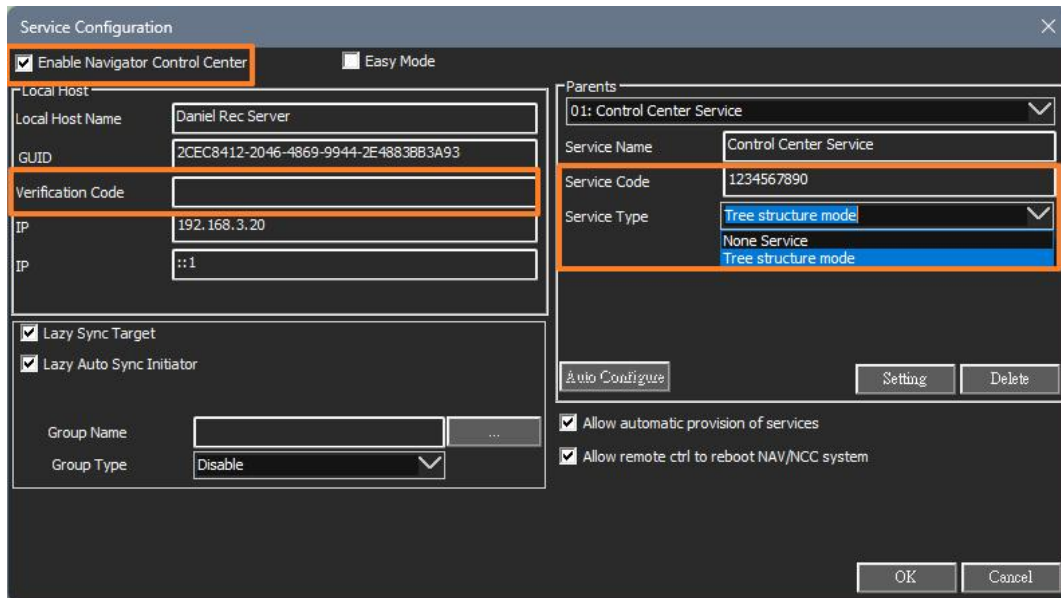

- Auto Configure: When the Easy Mode is turned on, directly click "Auto Configure", and it will automatically be carried into the open server center mode, Control Center TVWall screen mode, and parallel permission mode
- Auto Scan Code: The default is 0, only the same code can be scanned.

Chapter 19.2.3 Navigator Screen Capture Streaming Setting

Open the screen capture streaming server settings, to provide other servers capture real-time desktop images

- Enable Screen Capture Streaming: Open screenshot streaming server settings.
- Enable Intel GPU encoder: Enable Intel CPU software decoding function.
- Enable Nvidia encoder: Enable Nvidia GPU hardware decoding function.
- Image Quality: The higher the quality, the more refined the picture.
- Max Frames Per Second: Channel picture refresh rate per second.
- Monitors to capture: Select the monitor to capture.

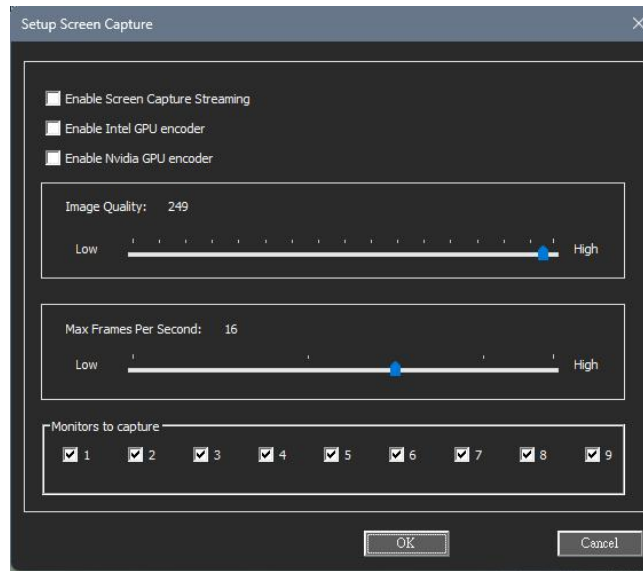

Chapter 19.2.4 Navigator Setup Receiver

The mobile app Phone Cam supports real-time video uploading to NAV. It can be used to transmit recordings and store video recording immediately in the event of a fire or traffic incidents. (Please refer to the Navigator Receiver User Manual for instructions.)

Chapter 19.3 How to set Mosaic TV Wall

In second group, please set the service type to Navigator TV Wall service, select Setting and TV Wall set up is complete.

When host has multiple monitors, one server group can only set one Mosaic TV Wall Server, assuming there are 2 monitors, server group 3 have to set second group monitor.

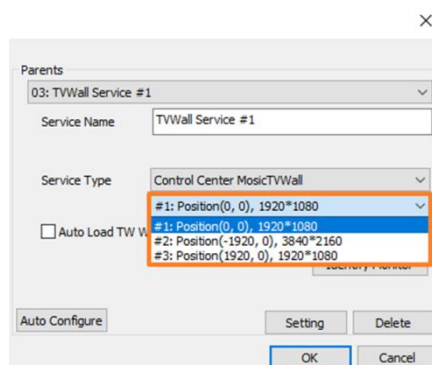

Please select Identify Monitor, and the screen will prompt the number for the user to confirm.

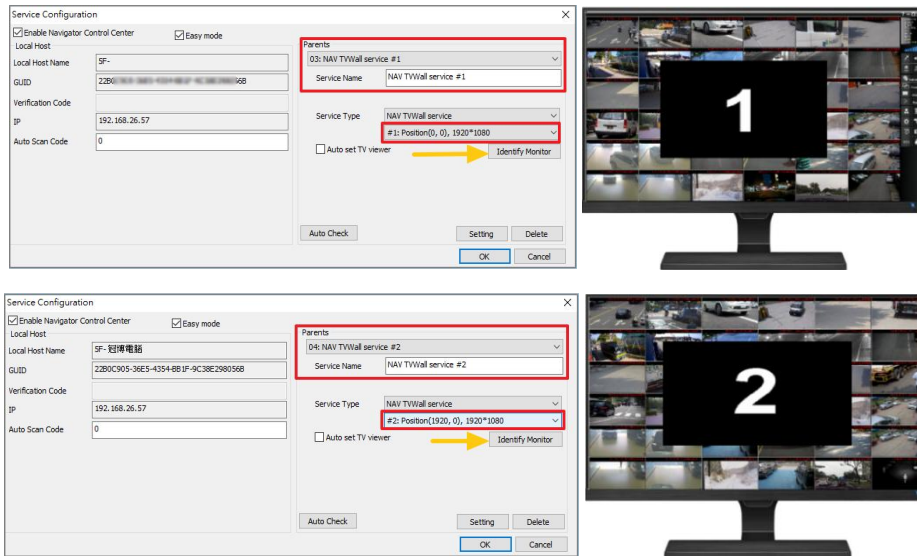

Chapter 19.4 Auto set TV viewer setting

Check Auto set TV viewer setting, Mosaic TVWall is automatically evoked when Control Center is turned on.

Note: You may set each TV Wall server group to automatically evoke or not.

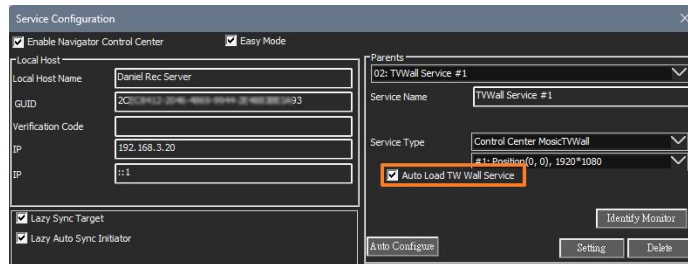

Chapter 19.5 Easy Mode

Check Easy mode and apply Auto Check, will automatically skip verification code and service code, this will enable to import Control Center Service and TV wall mode easily and quickly, click on Setting to complete easy setting.

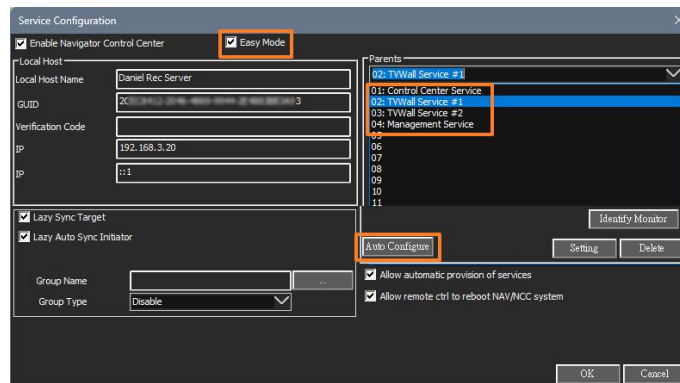

Note: When a main host has many monitors, will automatically be carried into all present connected screen settings.



Chapter 19.6 Easy Mode Advanced Function

- Lazy Sync Target: Easy mode, automatically synchronizes the target.
- Lazy Auto Sync initiator: Easy mode, automatically synchronizes enable.
- Allow automatic provision of services: Allows automatic service activation.
- Allow remote ctrl to reboot NAV/NCC system: Allows remote reboot of the NAV/NCC server.

Chapter 20 Automatic Number Plate Recognition (ANPR)

Navigator AI Number Plate Recognition (ANPR) can support features including denial list and allowed list for gate control automation or city surveillance purposes. The purpose of denial list is to prevent unauthorized vehicles entering an area, thus the system can pop up a window for alarm notification, whereas allowed list can provide access to the area by opening the gate. Our Navigator ANPR license plate recognition can also set exclude list to increase the recognition rate.

Features of AI Number Plate Recognition Engine

- Support up to 1080P resolution at 48 FPS.
- Support 2/4/6/8 channels recognition via Navigator.
- Each channel can recognize up to 6 car plates.
- Support group denial list, allowed list and exclusion list setting.
- License plate character size and license plate character length can be set.
- Support real-time and video playback identification display.
- Support for license plate JPEG snapshots.
- Support our IO Box interfacing external devices for gate control.
- Support database synchronization for denial list and allowed list.
- Support up to 200 km recognition speed.
- Support HTTP SDK integration.
- Support Navigator.

Chapter 20.1 Before Using This AI Engine

Please read our IP camera user manual for operating the camera. This user manual only focuses on the AI Engine feature of the software. AI Engine software is a demo program that allows you to verify recognition results, after our AI Engine is properly installed.

Chapter 20.2 Caution

Do not use the number plate recognition system with the gate or barrier control for vehicle speed over 10KM/h or 6MPH due to recognition rate limitation. This will cause a vehicle crash or accident to the gate or barrier control.

Chapter 20.3 Windows Version 10 Cycle Data Table

Different Windows versions may not be able to upgrade the code. It is recommended to download and install the latest code and Win 10 professional version from the Microsoft website.

System	Version	Official code	Release date
Win10	1909	19H2	2019/11/12
Win10	2004	20H1	2020/05/27
Win10	20H2	20H2	2020/10/20
Win10	21H1	21H1	2021/05/18
Win10	21H2	21H2	2021/10/05
Win10	22H2	22H2	2022/10/18
Win11	21H2	22H2	2022/09/20
Win11	22H2	22H2	2023/01/20
Win11	23H2	23H2	2023/11/11

Format :  Old version is not recommended  Old version, still supported Standard Version
 Standard version  The latest preview version

Chapter 20.4 Windows Version Corresponding Graphics Card Series

It is recommended to use the latest version of Windows code, so no need to worry about matching graphics card driver version.

Standard Video Card Compatible With Windows Version		
NVIDIA Chip architecture	Windows 10/11	NVIDIA Graphics Card ModelNo. (Supports super*Ti)
Pascal	V. 1607or later	10 Series:GT1030,GTX1050,GTX1060,GTX1070, GTX1080,TITAN X/XP
Turing	V. 1709or later	16 Series:GTX1650&1660
		20 Series:RTX2060&2070&2080,Titan RT
		Quadro Series:RTX 4000,5000,6000,8000
		Tesla Series: Tesla T4
Ampere	V. 1803or later	30 Series:RTX 3060,3070,3080,3090
Ada Lovelace	V. 21H2or later	40 Series:RTX4060,4070,4080,4090
Format : Graphics card is not recommended Minimum specification 2CH Standard specification 4CH Highest specification 8CH		

Chapter 20.5 Install CUDA driver

The current AI version is 11.2. Before using AI engine, remember to install the CUDA 11.2 installation file first. It is recommended to update the graphics card driver to the latest version, usually with a backward compatible version number.

CUDA Toolkit	Minimum Required Driver Version for CUDA minor version compatibility*
CUDA 11.5.x	>=456.38
CUDA 11.4.x	>=456.38
CUDA 11.3.x	>=456.38
CUDA 11.2.x	>=456.38
CUDA 11.1 (11.1.0)	>=456.38
CUDA 11.0 (11.0.3)	>=456.38
Format : Graphics card minimum version CUDA Current Version	



Chapter 20.6 CUDA Version Compatible with Graphics Card Series

Use the CUDA version with compatible graphics card series, otherwise the AI Engine system will not work properly.

CUDA Version and Graphics Card Combination		
CUDA Version	Graphics Card Series	NVIDIA Graphics card model (Support super*Ti)
CUDA 10.2	16 Series	GTX1650&1660
CUDA 11.2	20 Series	RTX2060&2070&2080, Titan RT
	Quadro Series	RTX 4000,5000,6000,8000
	Tesla Series	Tesla T4
	30 Series	RTX 3060,3070,3080,3090
	40 Series	RTX 4060,4070,4080,4090

Format : Not recommended CUDA10.2 CUDA11.2 CUDA11.2

Chapter 20.7 OpenVINO™ Compatible with GPU Model Series

If an Intel integrated GPU is used, our ANPR AI series products have a built-in OpenVINO™ driver. After installing our ANPR AI series, please enable OpenVINO GPU in the system settings.

The CPU i7-level is recommended, must have a GPU internal display to enable the OpenVINO function.

Intel CPU code explanation:

- Suffix letter K: High performance overclocking and support internal display at the same time.
- Suffix letter F: No internal risk.

OpenVINO™ and GPU Model Series Combination	
Intel Mode	Intel GPU
I7-7700/K	HD630
I7-8700/K	UHD630
I7-9700/K	UHD630
I7-10700/K	UHD630
I7-11700/K	UHD750
I7-12700/K	UHD770

Format : Not recommended Supported Recommended Specification Latest Specification

Chapter 20.8 AI Engine Compatible Graphics Card Series

To use the AI Engine version, the compatible graphics card series must be used, otherwise the AI Engine system will not work properly.

AI Engine Version and Graphics Card Series Combination	
Graphics Card Series	AI EngineVersion
20 Series	AI Engine 1.0.7.140
30 Series	AI Engine 1.3.0.140
40 Series	AI Engine 1.3.0.140

Format : 20 Series Graphics Card 30 Series Graphics Card 40 Series Graphics Card

Chapter 20.9 AI Engine Back-end License Plate Recognition Settings

The AI Engine channel needs to correspond to the Navigate channel. For example, the 1st channel, click on the Alarm icon settings -> ANPR Setting -> check the Enable ANPR.



Chapter 20.10 Navigator Software Setting for AI Number Plate Recognition

Click Navigator software and select camera properties. Click on ANPR Group Setting and make sure that the communication of AI Number Plate Recognition is at 8592 port.

- Enable service: Enable AI Engine & AI function.
- Enable watch dog service: Automatically watch dog detection mode.

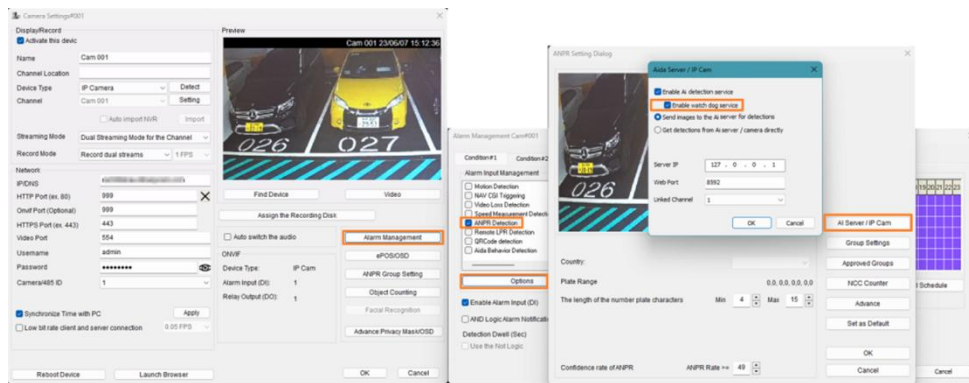

Please click the camera settings button or the right mouse button on the channel to enter the properties page. Please check "ANPR Detection" option in the "Alarm Input Management" item of the alarm management page. After checking this item, click "Options" to enter the settings.

- Camera Properties->Alarm Management->Click on ANPR Detection

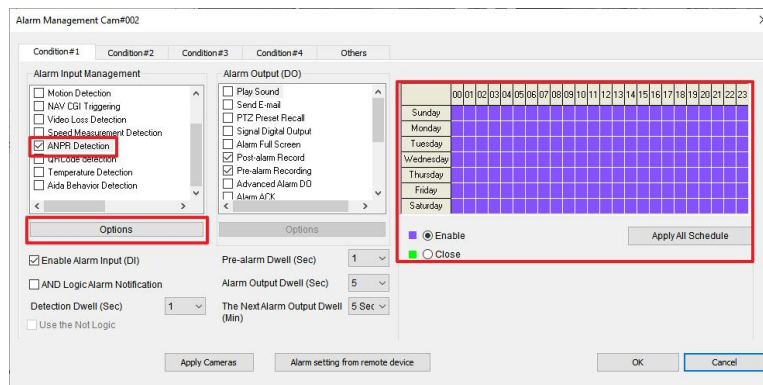

Note: When using Navigator VMS and AI Engine, there is no need for opening AIEngine.exe for saving CPU usage.

Chapter 20.11 License Plate Character Height Adjustment

The maximum and minimum length of characters to identify the license plate can be defined according to the requirements of license plates in different countries, which can shorten the time of the license plate search engine.

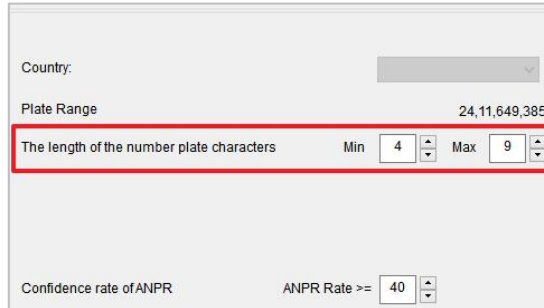

Chapter 20.12 ANPR System List Setting

Each group of license plates can be set as a group, for example, preset groups such as "white list", "denial list" or "exclusion list". It is also possible to add a group and specify its function application group, and set the corresponding output after the license plate is detected.

To set license plate group, click "License Plate Group Setting". After entering the license plate database, create a group from the list according to the ownership of the license plate, trigger the alarm with this group, and other settings:

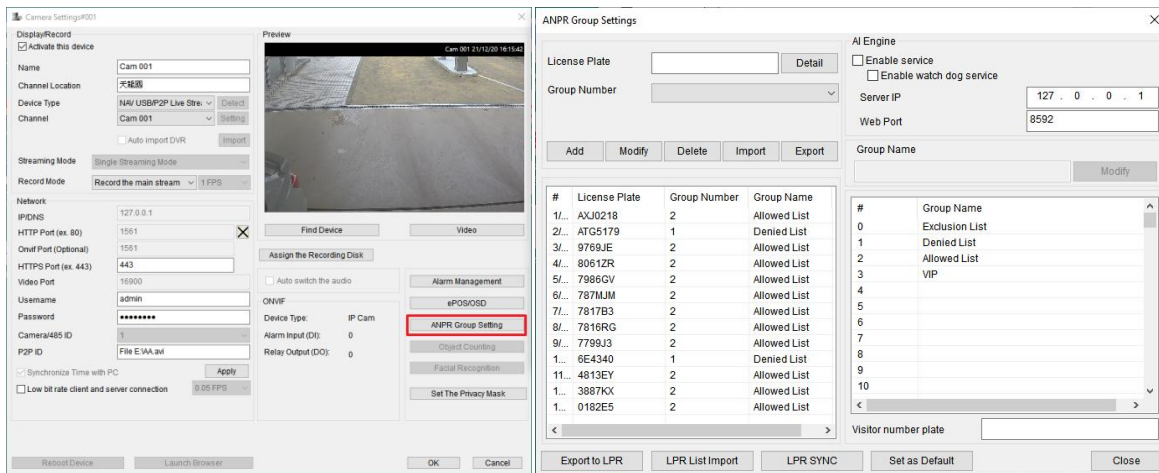

Chapter 20.13 License Plate Import/Export List

Support import/export list report. The function displays license plate and vehicle information in the Excel CSV file format.

Number	Type	Name	ID	TEL	Parking No	Door No	Address						
03		Esther	E0122	(714) 8		ND00	300						
22		Abner	E024	(951) 4		9	554						
66		Jacob	H021	(559) 5		1	Knoc			9915 Casey Dr			
AE		Jet L	A721	(626) 3	CA-9	7J00	37						
AF		Chris	K010	(903) 9		HNO	Rich			36 Granite Ave.			
CS		Kazu	N202	(69) 88	TX-6	GX-3	7						
FM		Benj	K146	(706) 2		7NO	Sta			San Francisco CA			
RC		Haile	U012	(310) 8		700	hand			San Francisco CA			
TD		Ael	E100	03-006	TX-5	GX-2	No. 1			Ln. 17 Shamei Jinsha Township Kinmen County 890			

Chapter 20.14 The Settings of AI Traffic Management

Click on Enable traffic detection for using AI traffic objects detections. For traffic behaviors, the behavior is defined in a traffic detection zone. There are four detection zones programmable for traffic objects. Follow the instructions below for setup.

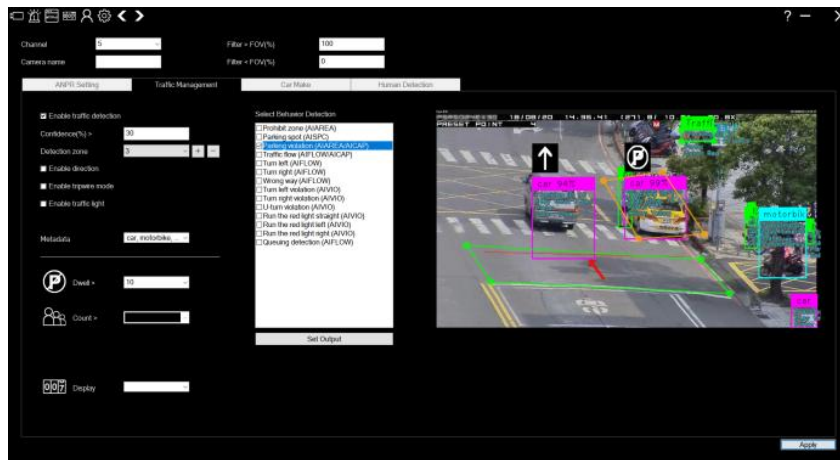

Note: It is important to disable “Enable traffic detection”, if traffic detection is not used to save CPU or VPU usage.

Chapter 20.15 Traffic Zones

Click on buttons for inserting or deleting a traffic detection zone. Once a detection zone gets added, drag the Anchor of the zone to fit the environment. There are up to 4 traffic zones for detecting the behaviors of traffic objects.

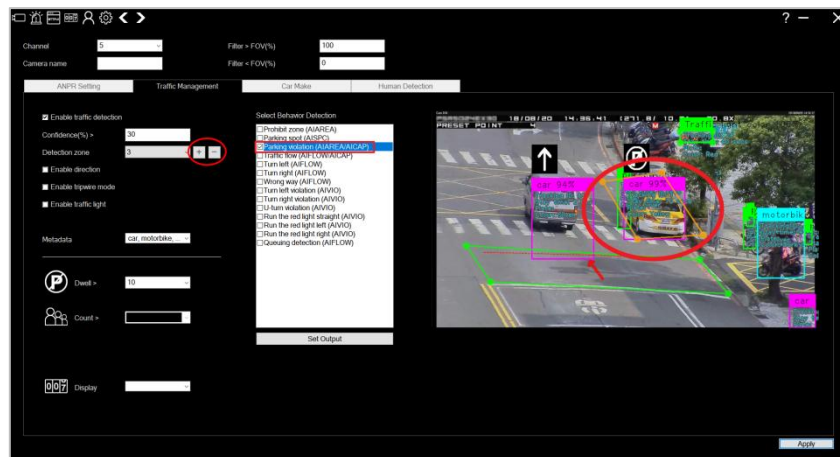

Chapter 20.16 Prohibit Zone Detection (Parking Violation)

To set up an alarm notification for an object entered the prohibited detection zone, please select the “channel” number for setting and key in the object names in “metadata”. Add a detection zone to desired area. Tick on “Prohibit zone detection”. Click “Apply” to save the settings.

It can be used in applications such as prohibited areas for vehicles, i.e. large trucks entering the urban district.

1. Add or delete detection area
2. Select behavior detection
3. Parking violation identification status
4. Enable the metadata, car, truck, SUV, etc for detection
5. Set the dwell time to detect the violation time

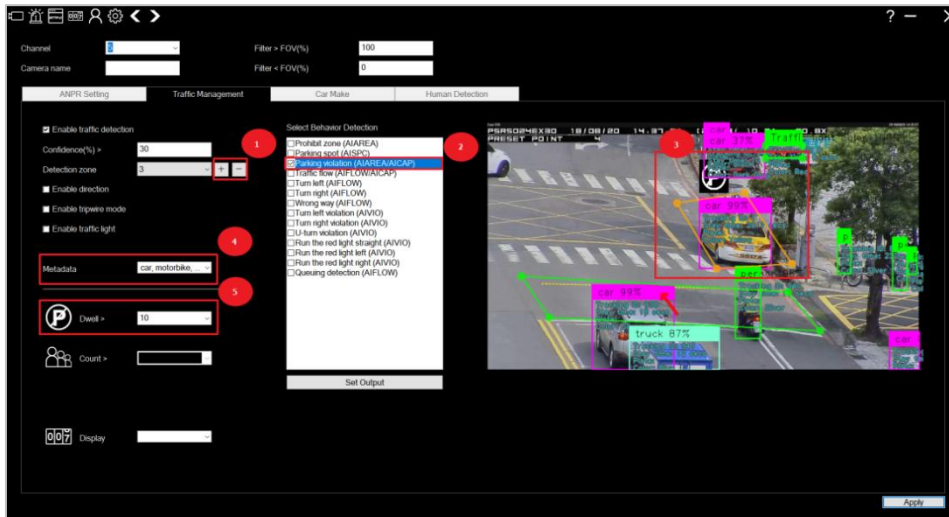

Chapter 20.17 Queuing Detection

To set up an alarm notification for the number of objects entered the detection zone reached the maximum occupancy, please select the “channel” number for setting and select the object names in “metadata”. Add a detection zone to desired area. Tick on “Queuing detection” and key in the number of objects in “**Count**”. Click “Apply” to save the settings.

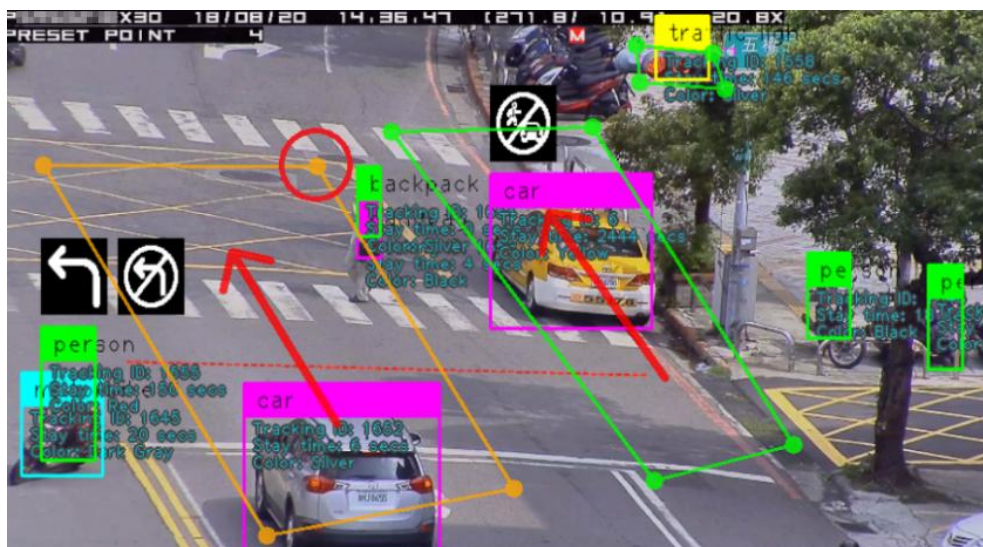

- Enable traffic detection: Enable AI traffic engine. Disable other AI engines for saving GPU load.
- Detection zone: Insert a zone for traffic behavior.
- Enable direction: Enable direction if traffic flows are needed such as turn left, turn right, and wrong way detection.
- Metadata: Select the object names for filtering the objects having a desired traffic behavior.
- Counter: A global counter for behavior event.
- Dwell: The time for parking violation.
- Count: The count of objects in a sense used by queuing detection.

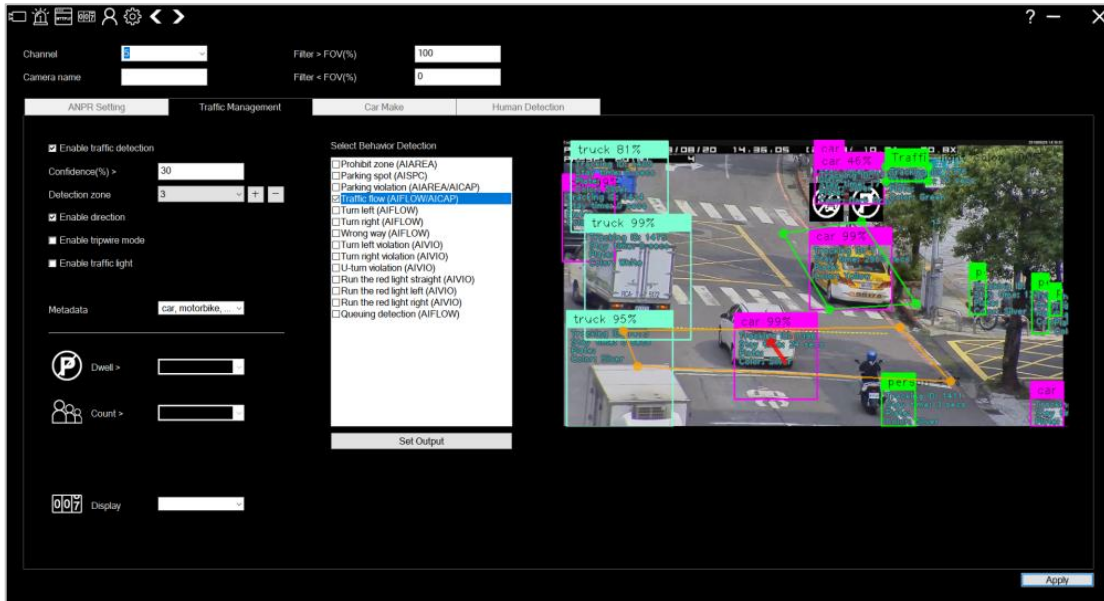

Chapter 20.18 Human Mask Detection Setting

To set up the mask detection and no mask detection of an object entered the detection zone, follow the instruction below:

1. Click on “Enable Human detection”. Please select the “channel” number for setting and specify “face, half_mask, mask” in “metadata”. Add a detection zone to desired area. Select “Mask detection” and/or “No mask detection” behavior. Click “Apply” to save the settings.

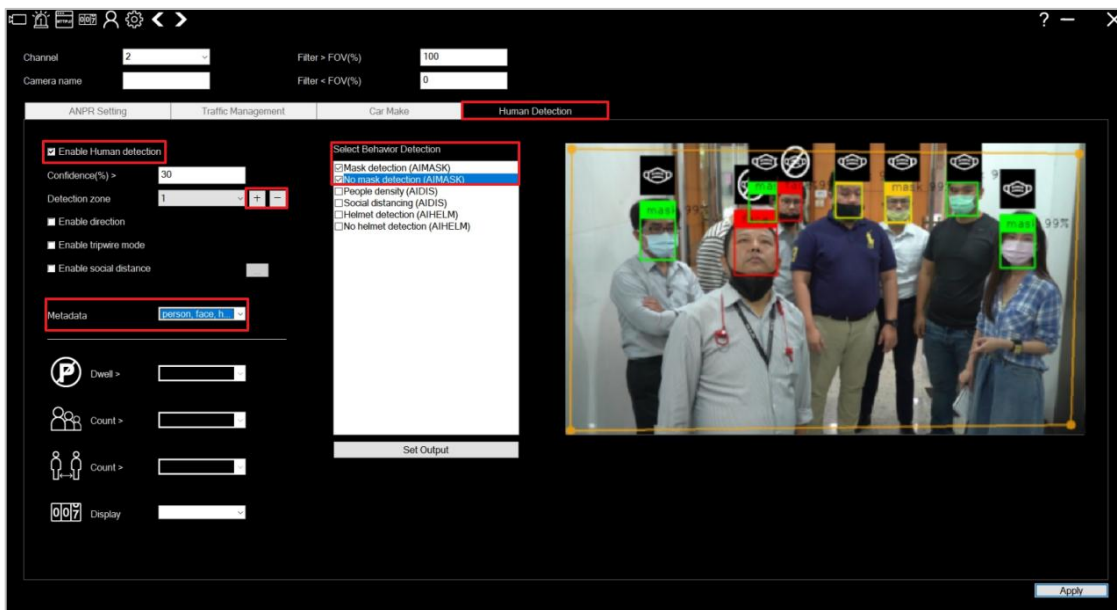

2. Configure the HTTP post by clicking on event icon. Then, click on “Enable HTTP notification”. Click on “Add” or select an event to “Edit” in “Notification events”. Then, type in URL field /cmd=naveventmsg?cmxcgido=1&audiono=1&interval=0. Click “OK” to save the settings. This is to notify the Navigator for playing an audio.

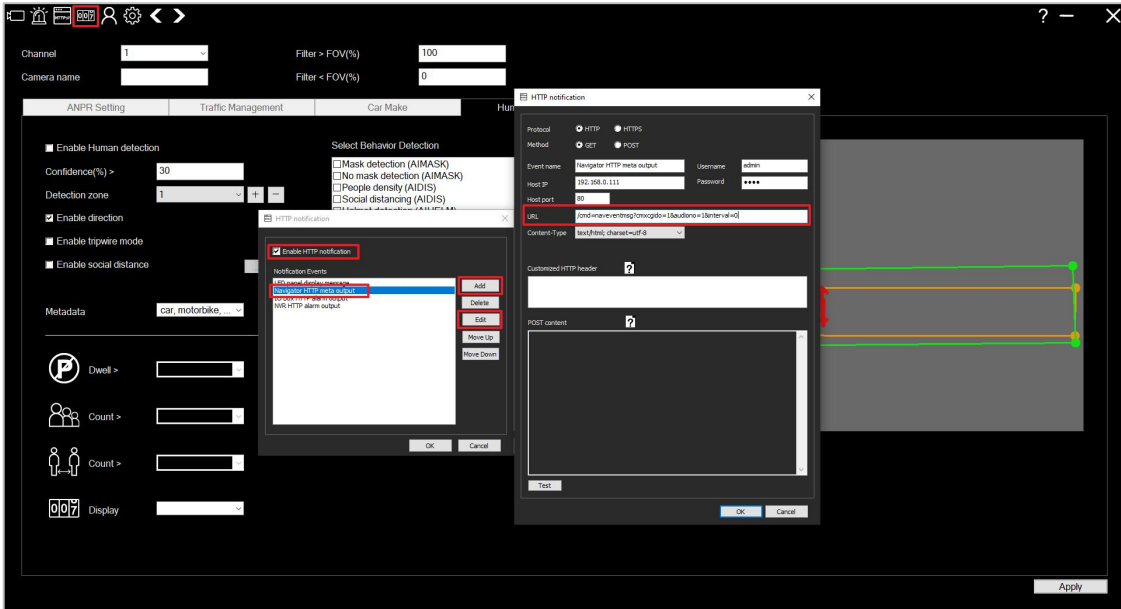

Note: “Navigator HTTP meta output” is an event name used as an example to show how to configure HTTP post. User may create a name for an event.

3. Enable the HTTP Post Notification to No Mask Detection. To enable, click on “No mask detection”. Press “Set Output” and tick on “Navigator HTTP meta output”. Click “OK” and “Apply” to save the settings.

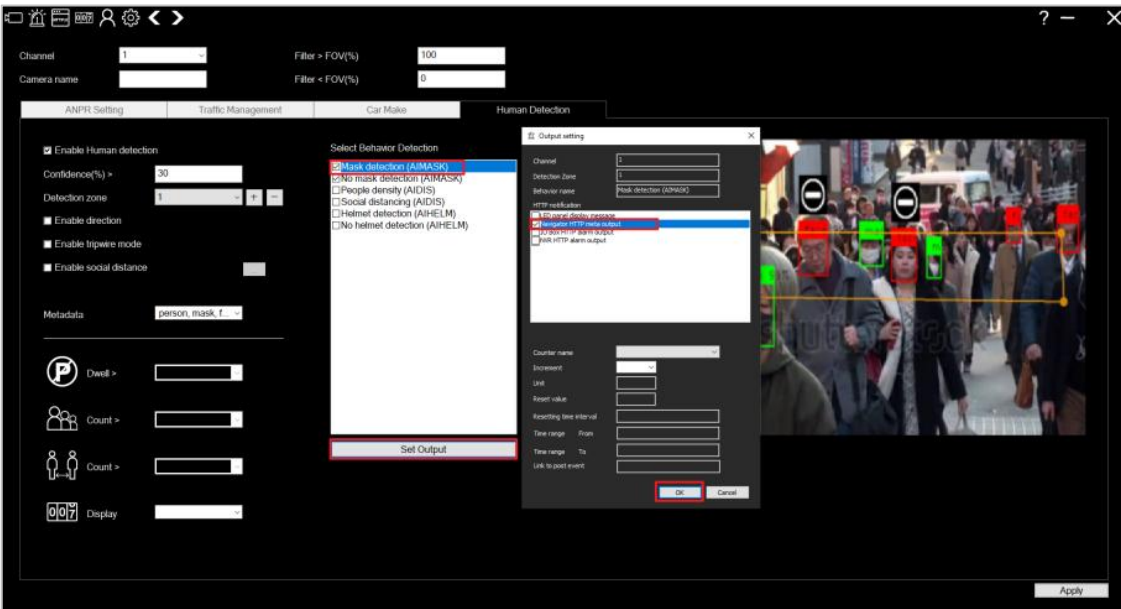

Chapter 20.19 Social Distancing

To set up social distancing, a rectangle area can be mapped to our AI software for calculating social distance. To do so, follow the setup steps below:

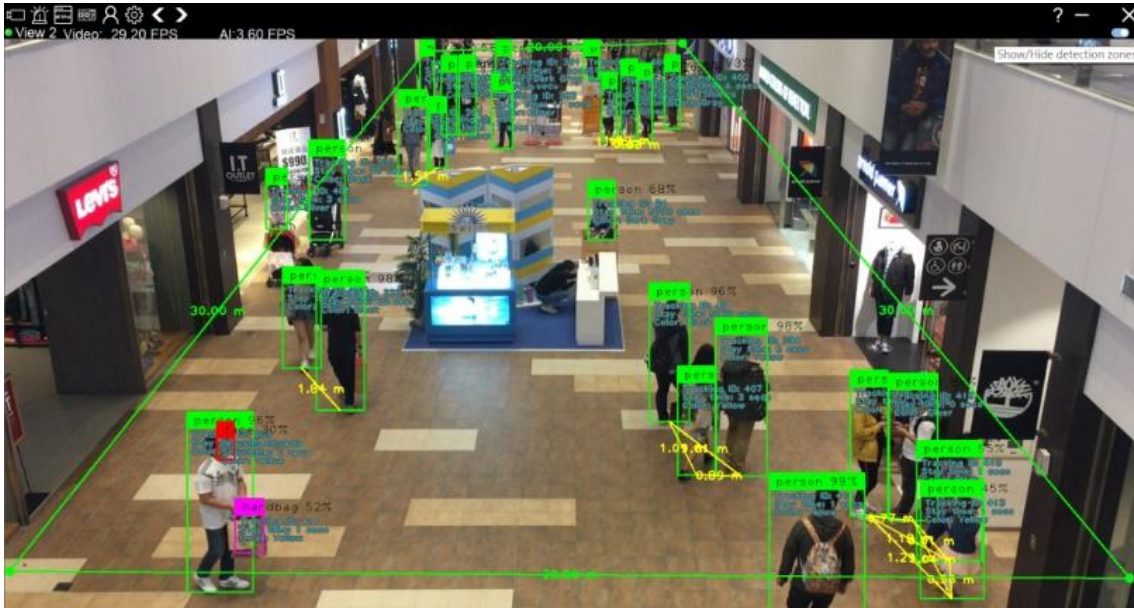

Chapter 20.20 Setup Social Distancing

To set up social distancing, enable “Social distance” feature. Select Social distancing behavior. Click on  button for setting social distancing. The social distancing feature works only in the rectangle area. The settings are described below:

- Unit: The rectangle area’s unit, meter or feet
- Width of detection zone: The X axis, width, of the rectangle area
- Depth of detection zone: The Y axis, height, of the rectangle area
- Display distance: If two people are in the social distance, show the detection lines.

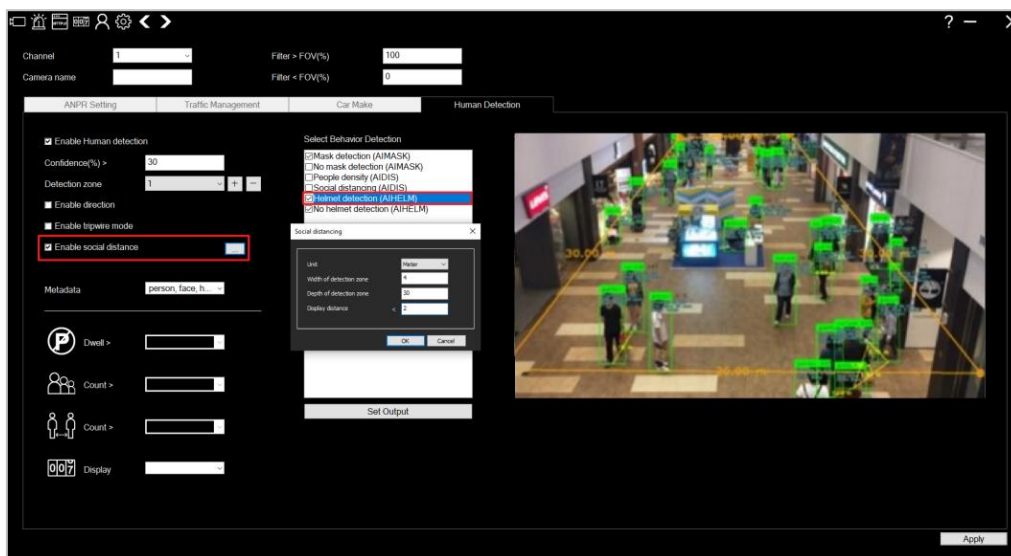

Once the social distance area gets set up, set the metadata to person. (Please select “Person” in the Metadata of the Traffic Management settings first. Then, select “Person” in Metadata of Human Detection settings.)

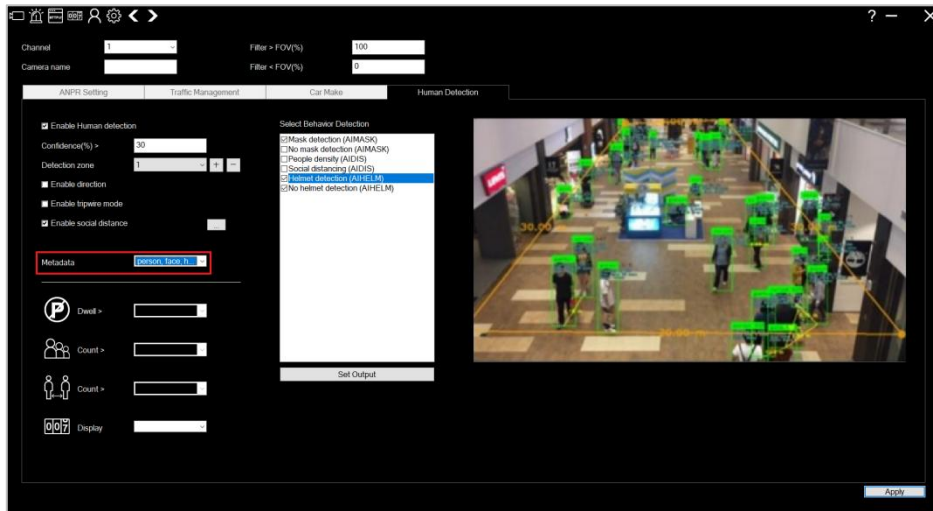

Note: There is only one detection zone that can support for social distancing feature.

The detection must be a rectangle area. Setup social distancing counter to, for example, 5 people distance. This can detect the social distance of these 5 people that are too close. You can also enable the display counter for verifying purpose. This can show how many times the area having violations of social distance.

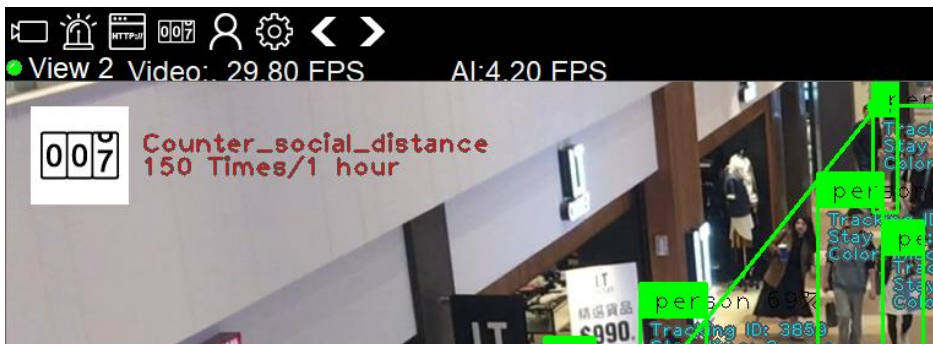

Chapter 20.21 People Density of AI Software

To count the density of people in an area, follow the steps below:

1. Create a detection zone.
2. Enable people density.
3. Set metadata to “people”.
4. Add the people density count.

Once the people detected in the area is greater than density count, you can program HTTP post or event counter for outputs.

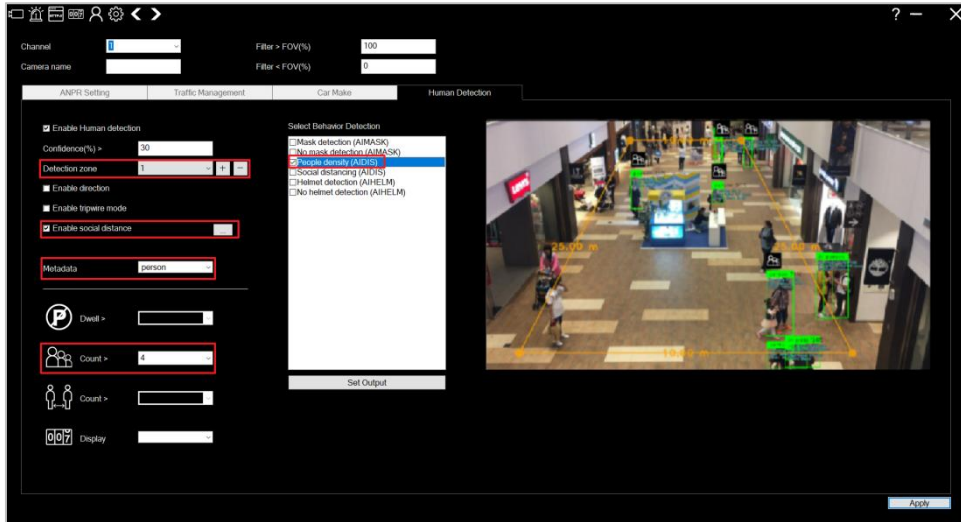

Chapter 20.22 Setting the Front-end Camera AI Function in Navigator

Launch the Navigator main program, click on "Camera Settings" button, "Alarm Management" -> check on "AI Behavior Detection" -> click on "Options" -> AI Server/IP Cam, click on "Auto detect AI IP Camera", tick on "Get detections from AI server / camera directly".

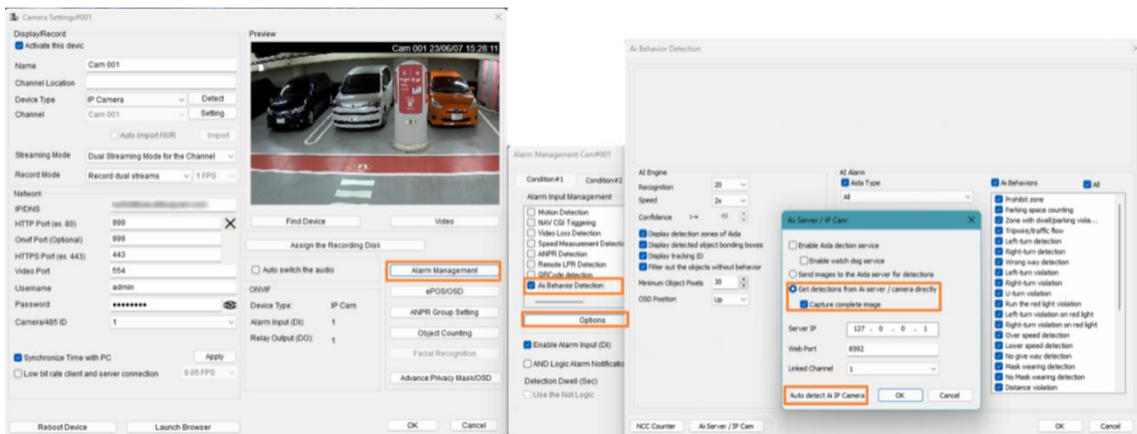

Chapter 20.23 AI Alarm and Behavior Detection Setting

With the Edge front-end camera authorization, check the AI Alarm AI Type and AI behaviors in Navigator.

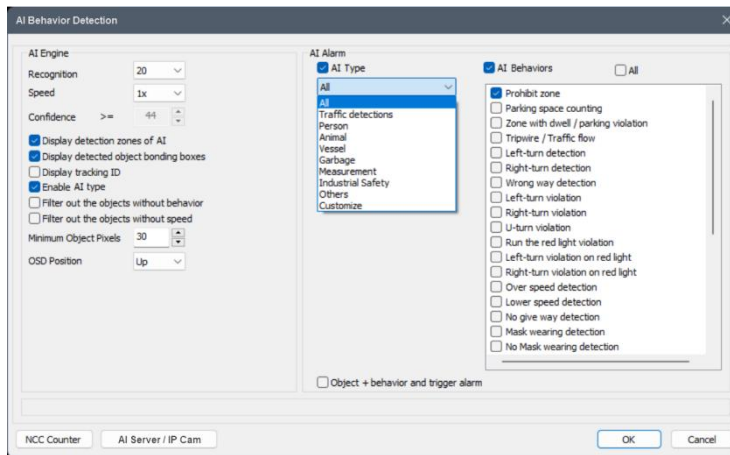

- Recognition: The channel recognizes the highest number of frames.
- Speed: The CPU accelerates, up to 4x maximum.
- Display detection zones of AI: Enable or disable the AI detection zone display.
- Display detected object bonding boxes: Enable or disable the real-time object tracking box display.
- Display tracking ID: Enable or disable tracking ID display (the object tracking box must be enabled first).
- Enable AI type: Whether to display AI type detection (for example: vehicle detection).
- Filter out the objects without behavior: If there is no triggered behavior detection, the filter will not be displayed, reducing the screen complexity.
- Filter out the objects without speed: If there is no triggered speed detection, the filter will not be displayed, reducing the screen camera complexity.
- Object + behavior and trigger alarm: When AI detection and behavior detection are triggered simultaneously, the alarm will be triggered.

Chapter 20.24 Setting of Front-end Camera Counter on the Webpage

Enter the Edge camera webpage -> select "AI Recognition" -> check the object classification and behavior detection, -> select "Counter01" as the counter -> customize the calculation unit, and once the setting is complete, the value of the counter01 in the lower right corner will change.

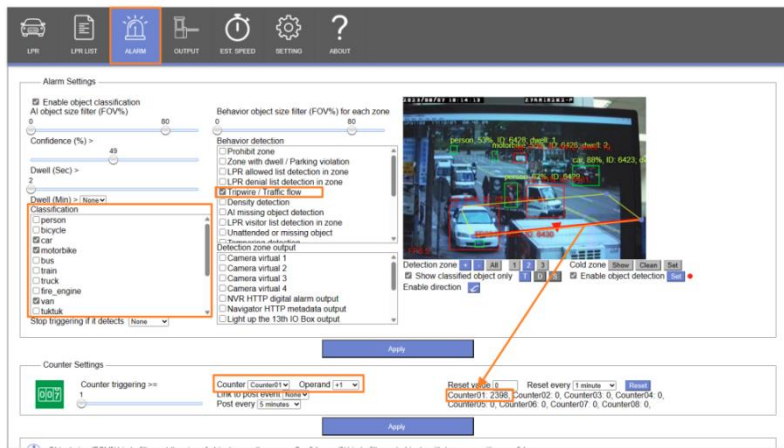

Chapter 20.25 Setting to Synchronize Front-end Camera Counter in the Navigate

When the counter is enabled on the webpage, NAV can synchronize the camera counter. Click on "Alarm Management" -> check "AI Behavior Detection" -> "Options" -> "NCC Counter" -> "Use AI Counter" -> select the corresponding counter "CNT 01".

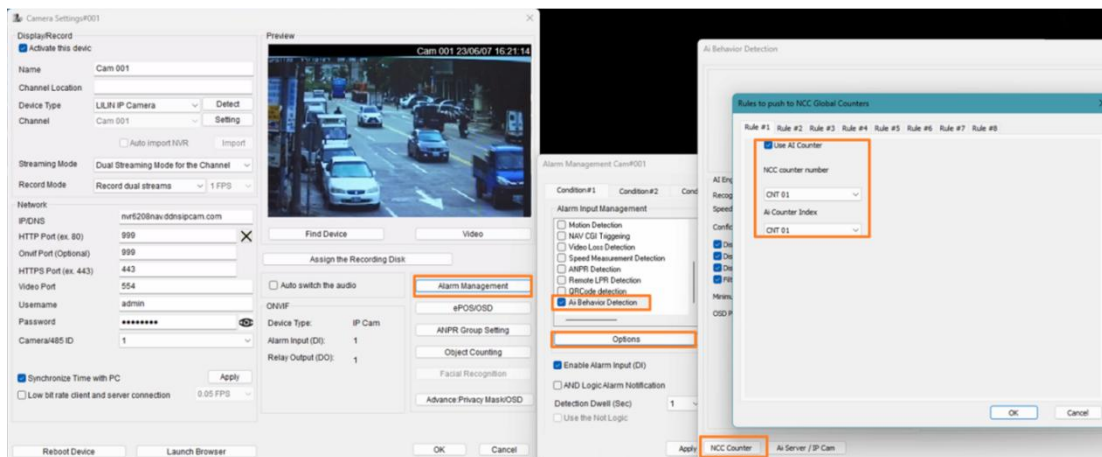

Chapter 21 Face Recognition (Premium Authorization)

The face recognition welcome system is a face recognition system on the NAV software platform. It compares the entered face database, and the faces can be classified according to the white list (VIP list), black list and visitor list, and trigger related alarms output.

Our world-class facial recognition accuracy, flexibility, and ease-of-use make Navigator software right choice for retail, access control, time and attendance, surveillance, denial list/VIP greeting management, and other applications.



Chapter 21.1 System Configuration

After a camera is configured, follow the steps below:

- Select Alarm Management
- Select facial recognition option from alarm input management
- Select alarm output, e.g., triggering DO of an IP camera.

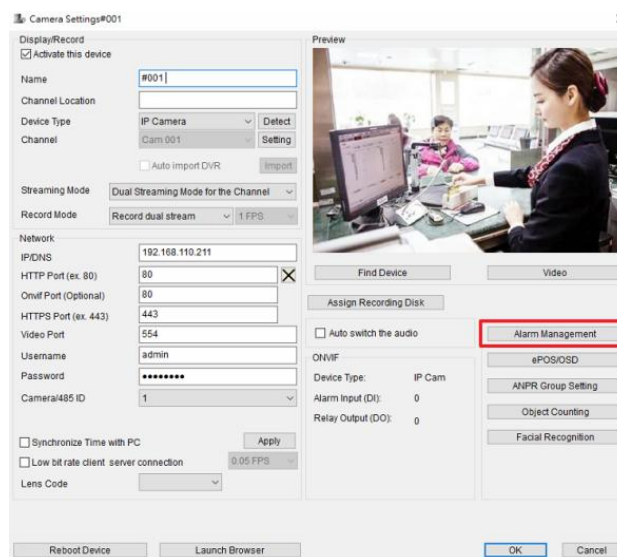

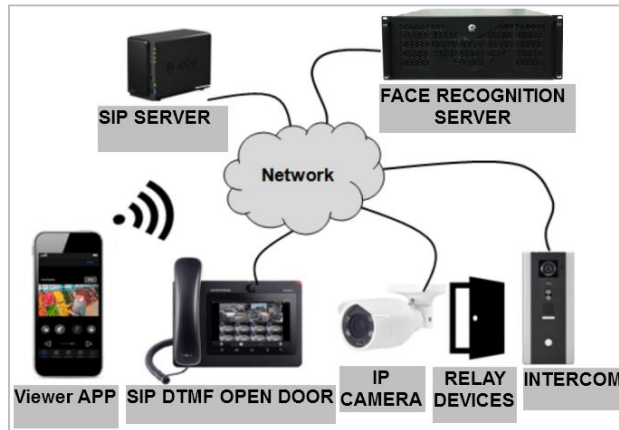
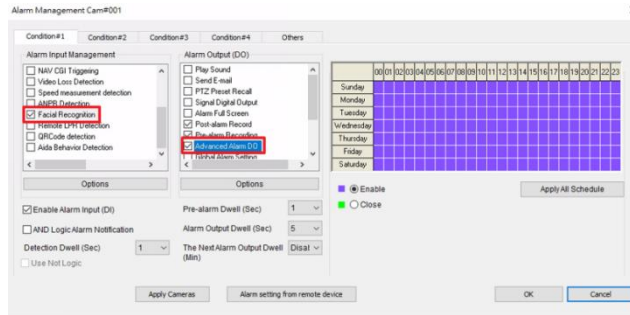

Chapter 21.2 Configure Detection Area & Facial Recognition

According to the installation site, you are able to define the recognition area. For defining the detection area, follow the steps below:

- Click Facial Recognition option.
- Click Options button.
- Use a mouse dragging on the video area for detecting area.

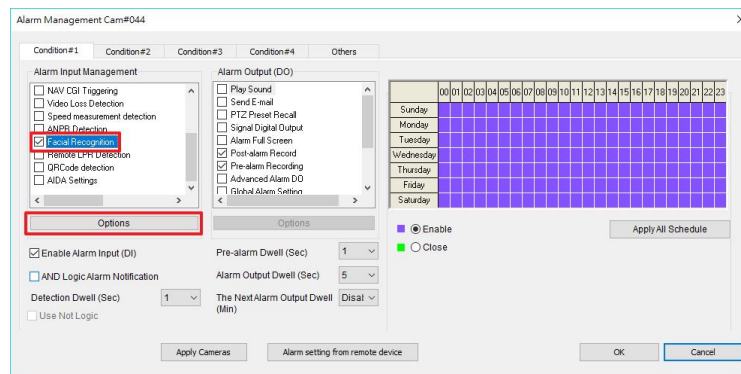

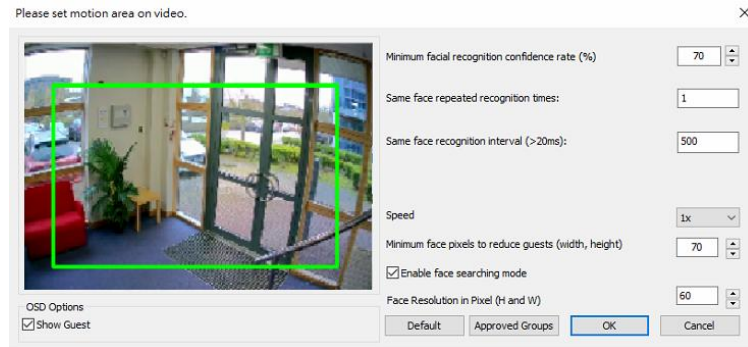

Other settings are described below:

- Image detection area: Support full image detection
- Minimum facial recognition confidence rate (%): When the confidence rate is achieved, will indicate successful recognition and trigger an alarm.
- Same face repeated recognition times: To achieve recognition accuracy, the number of times the same face is recognized for a successful facial recognition.
- Same face recognition interval: Total number of recognition interval of the same face.
- Speed: 1x speed represents 1 CPU thread. The faster the speed, the higher the CPU usage.
- Minimum face pixels to reduce guests (width, height): When lower than minimum face resolution, the face will not be recognized.
- Enable face searching mode: Support facial recognition tracking.
- Face Resolution in Pixel (H and W): The pixel size of the photo after face recognition
- Show Guest : Display guest function

Note: Reduce guest is to adjust level required to increase the face recognition match to data base.

Chapter 21.3 Facial Recognition and Alarm Output

After face photos are added into facial recognition database, the face photos can be grouped into different lists. Based on the groups, you are able to trigger an alarm output for a grouped list. To set, select as per your requirement from Alarm Output -> Alarm Input Management -> Option -> Define motion area (optional) -> Approved Group -> Approved Group Name > OK

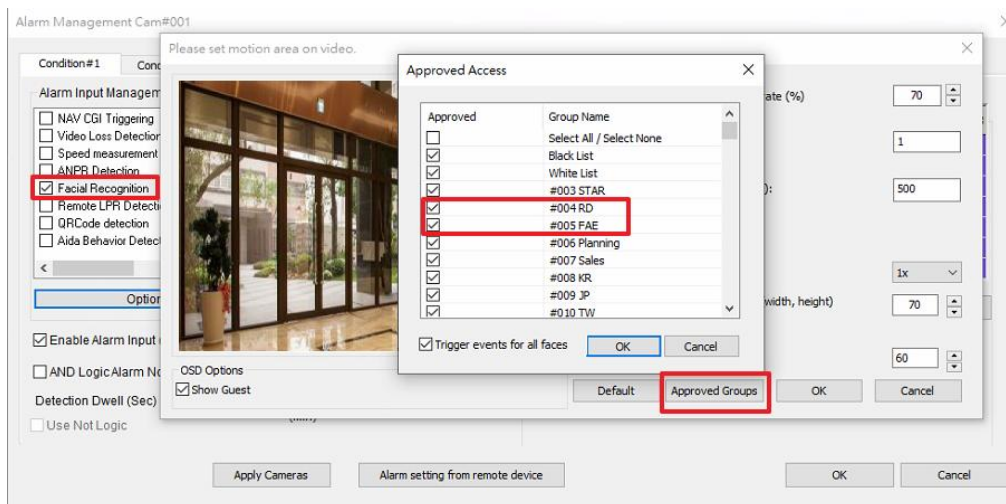

Chapter 21.4 Set Alarm Output Settings for Applications

The alarm outputs for a detected face can be triggered for many applications.

- VIP greeting: Enable Alarm Full Screen with OSD display for the VIP guest.
- Access control: Enable Signal Digital Output can trigger DO of an IP camera for opening a door.

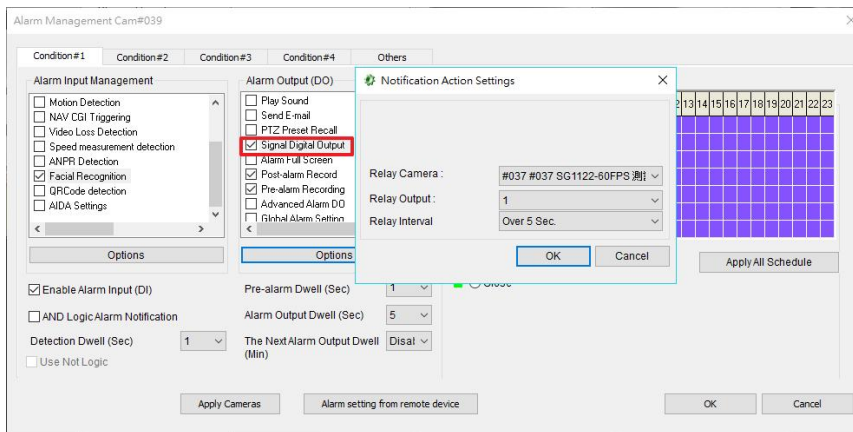
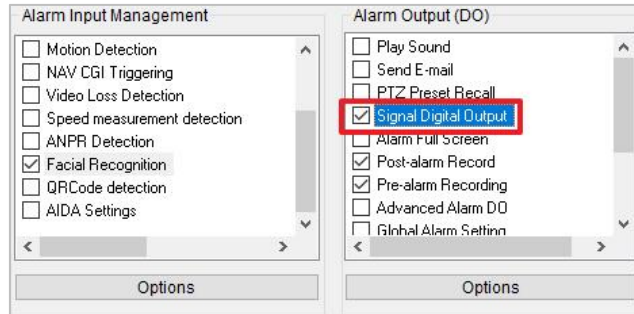

Chapter 21.5 Schedule of Facial Recognition Triggering a Digital Output

For access control application, IP camera relay output can connect to an access control for opening a gate or a door. You can also apply the schedule for weekdays for automation. To set, select as per your requirement from Alarm Output -> Alarm Input Management -> Enable Alarm Notification Schedule Day/Time -> OK

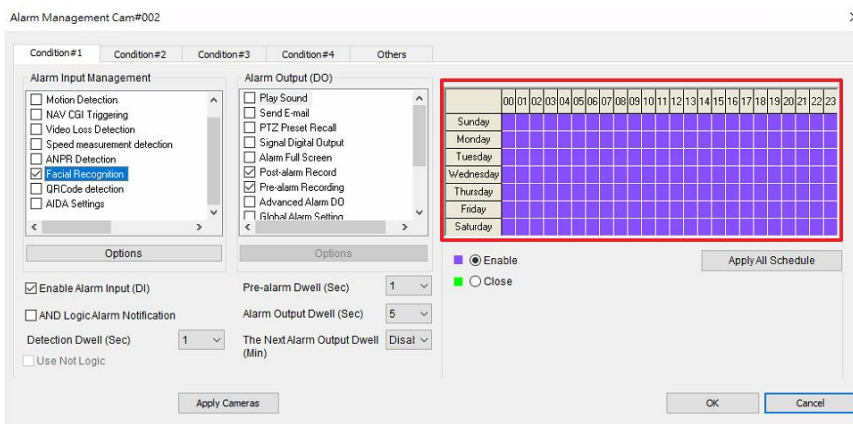

Chapter 21.6 Add Faces Photo into Database

In camera property dialogue box, click Face Snapshot button. The snapshot of the Facial Recognition dialogue box shows up for adding a face photo and entering personal information.

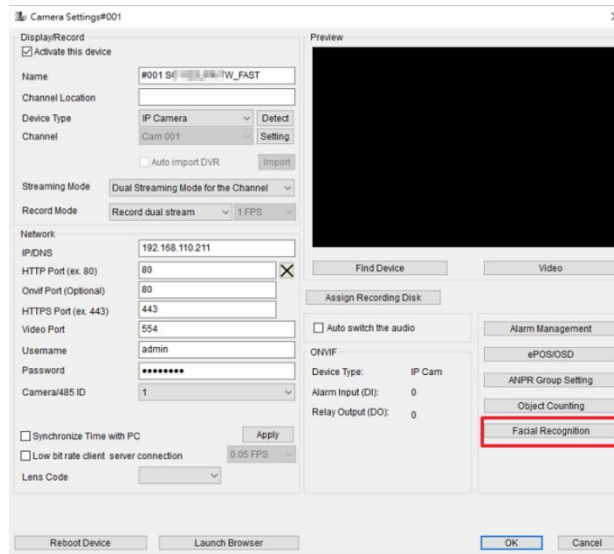

Chapter 21.7 Add Photos Database for a Face

For adding face photos, follow the steps below:

- Enter the name.
- Click on “...” button for adding Group button.
- Select the group name.
- Click on the name list for deleting or modifying the person’s information.

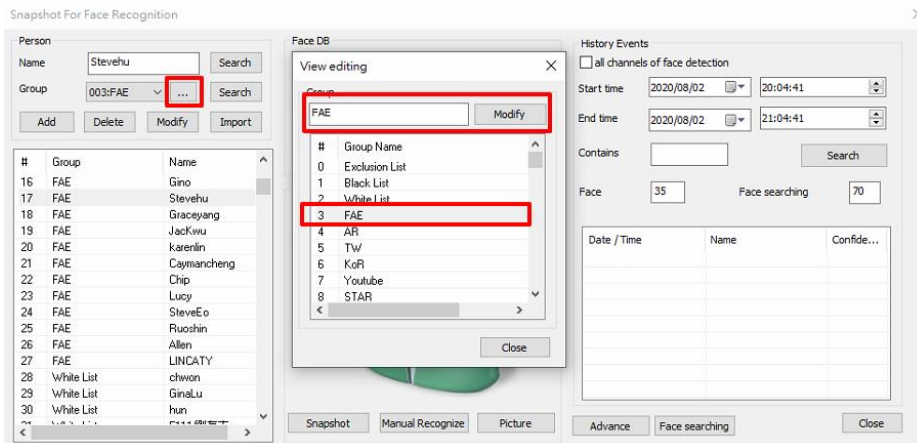

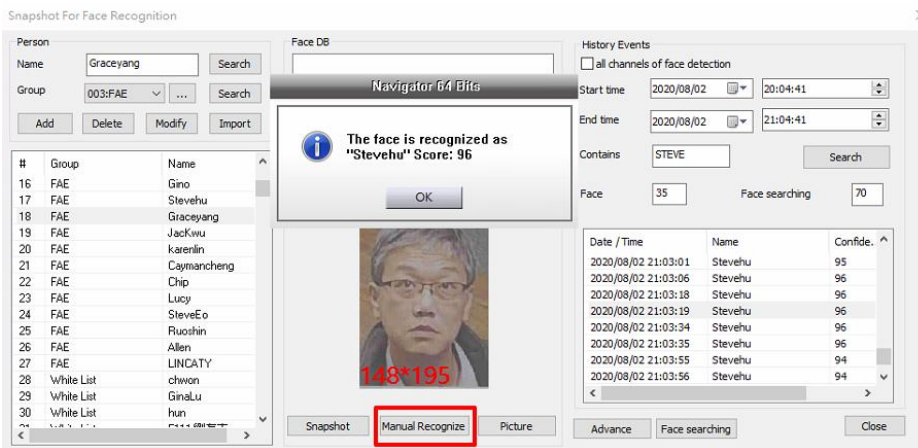
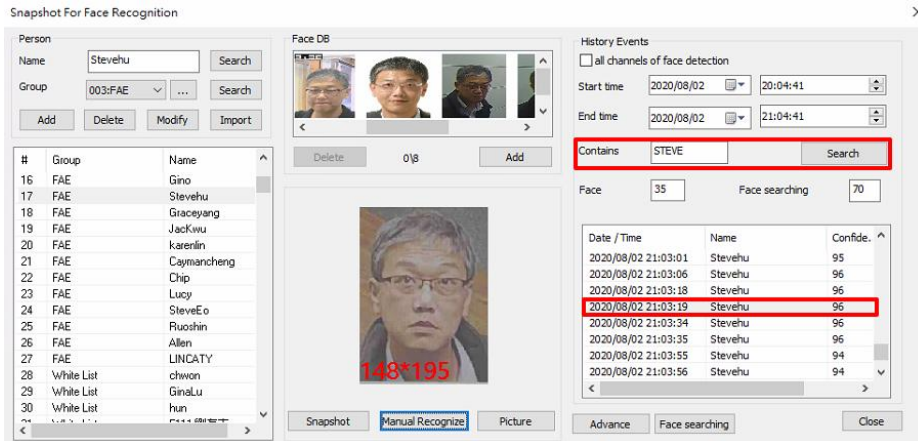

Note: Manual Recognize is to know the level of recognition.

Chapter 21.8 Adding Photos into Database

For adding a photo into the facial recognition database, you can click on Snapshot or click on Image File button. After a photo is loaded, you can click on Add button for adding into the facial recognition data base.

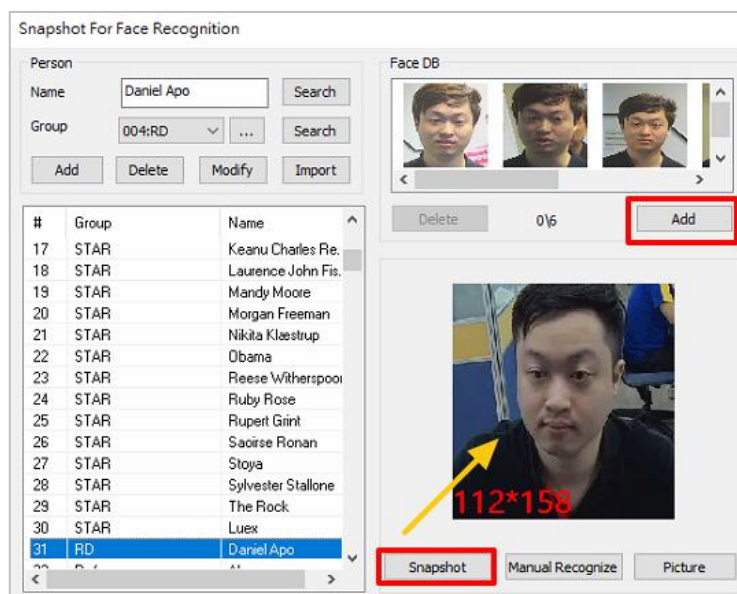

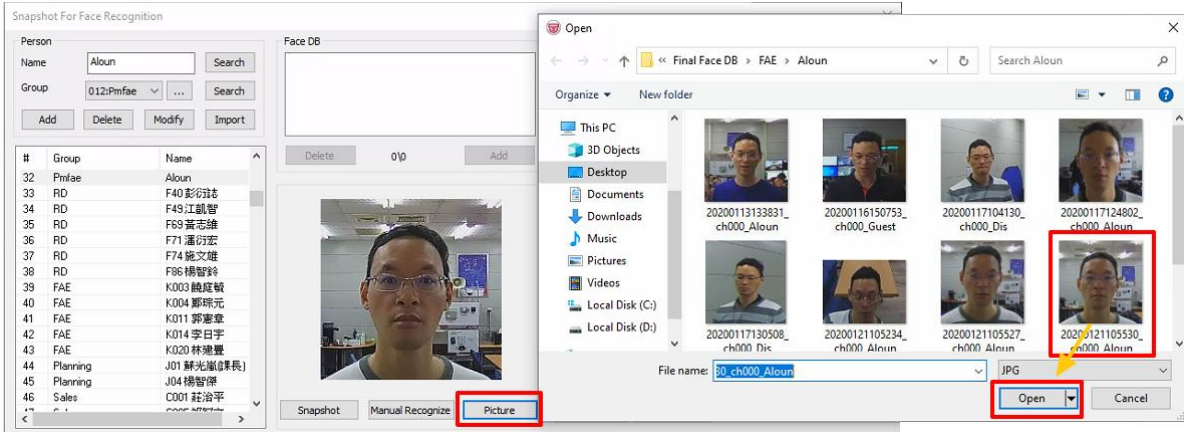

Note: The face of the photo needs to meet minimum pixel requirement.

Chapter 21.9 Historical Recognized Data

The face photo recognized will be saved in the History Event list. Click on the name, the recognized photo can be displayed in the temporary area. Click Add button to add the photo to the database. If a face is not recognized, the face is added into guest list. You can add the photo into a database for elevating the recognition rate.

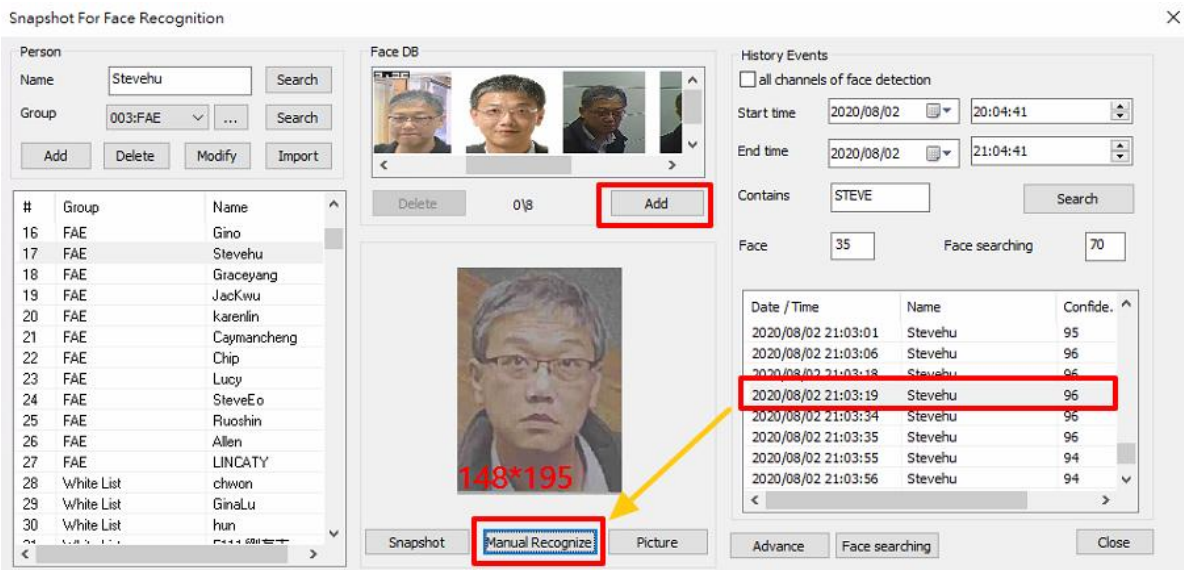

Note: It is highly recommended to have photos in different angles of a person.

Chapter 21.10 Historical Guest Face Tracking Search Mode

You can customize the search by date and time, search for guest recognition in the History Event list, and edit the guest as black list or white lists, and etc.

The faces can also be searched through picture, will compare with the face database to recognize the similar picture, and edit the verified identity of strangers in the list.

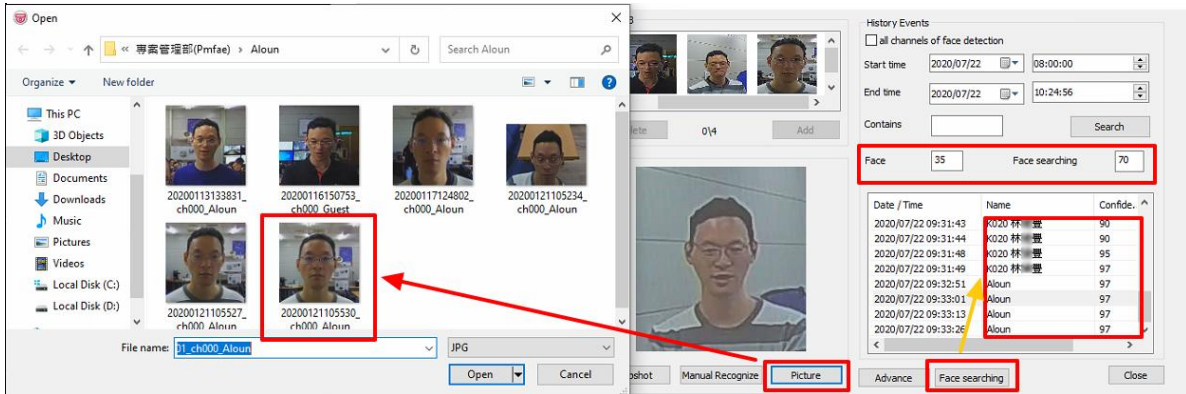

Note: The face pixel size and confidence degree of the search conditions will increase or decrease the search time.

Chapter 21.11 Search the Name for the Video

Click on playback button and select Facial Recognition option. You are able to search the entire name list of recognition.

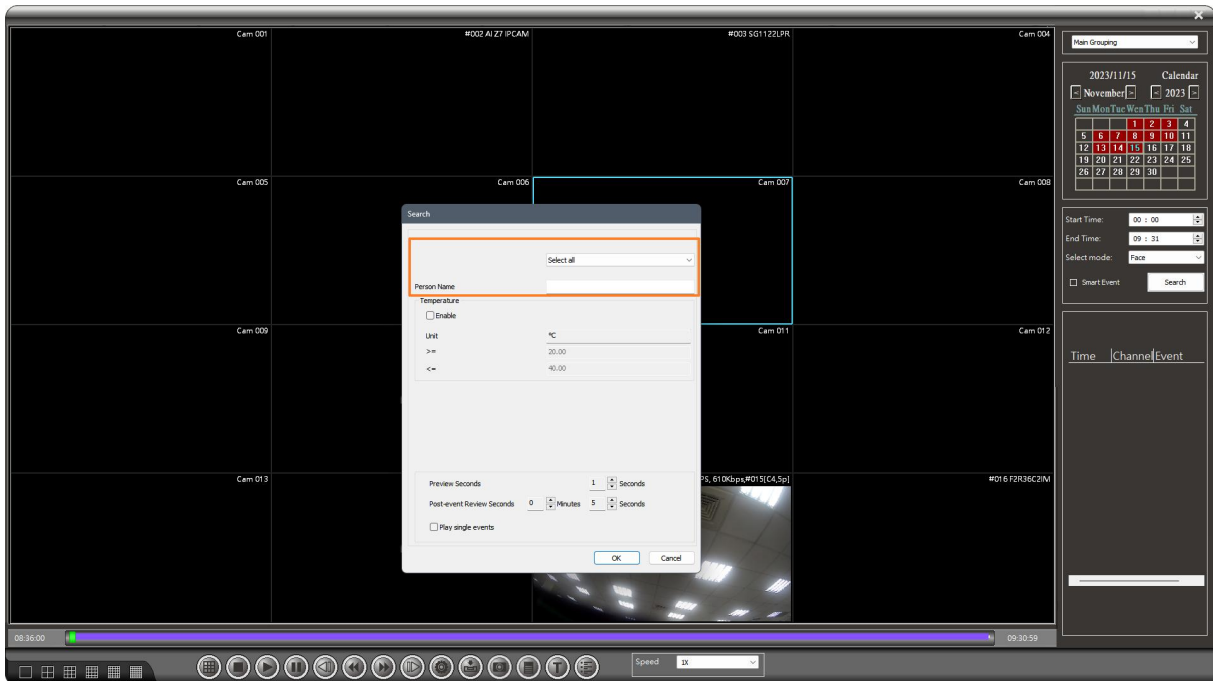

Chapter 21.12 Playback

Click on the names after recognition for video playback.

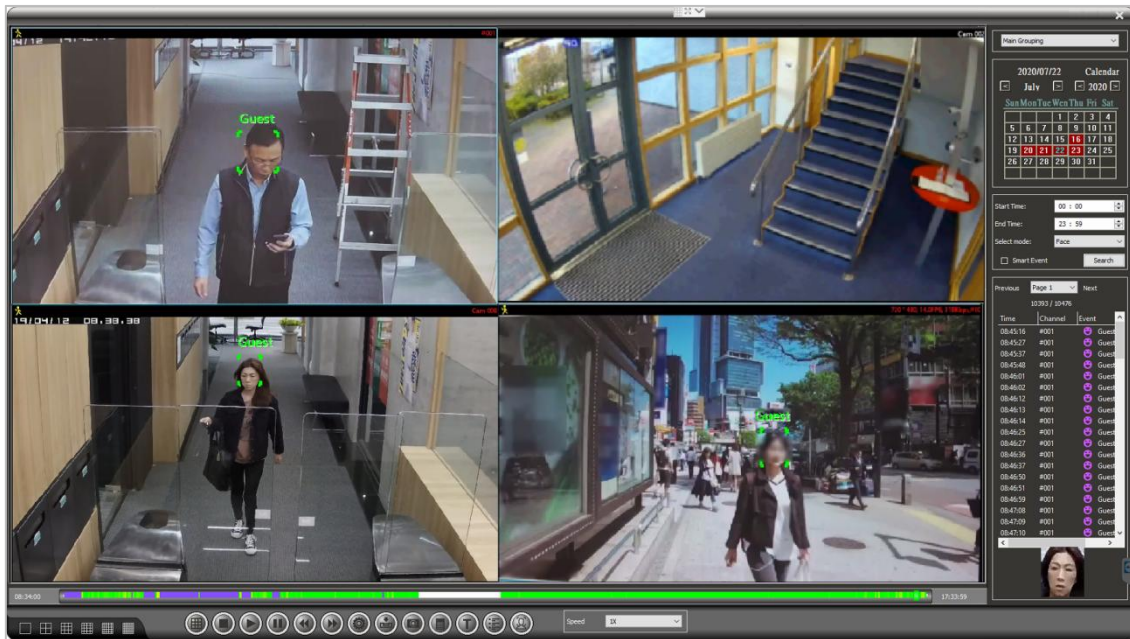

Chapter 21.13 Advance Facial Recognition Setting

Enable the face API command, go to “Advance” -> check the “Enable web API checking service”, and then you can transmit the command to the facial recognition host through the remote transmission.

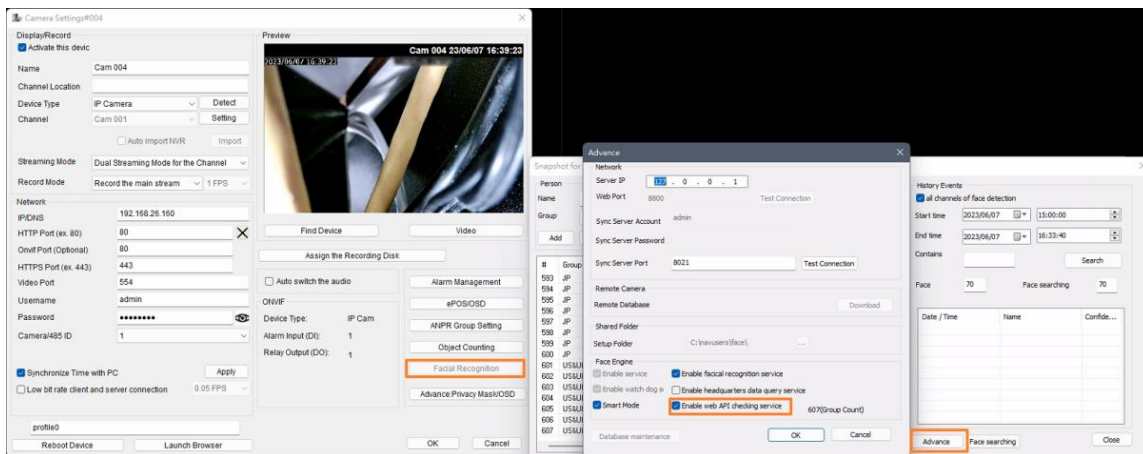

Chapter 21.14 Installations

For better recognition rate, follow the guidance for installation cameras.

- The environment of facial recognition cameras needs be at least 450Lux.
- The shutter speed of the camera should be 1/60 sec or 1/50 sec.
- Leveled camera installation facing a face at distance 3-5 meters.
- The pixel size of the photo should be 100 x 100 or higher.
- Do not use 4K cameras to slow down the recognition speed.

The following pictures are not good for facial recognition.

Angle of the face	Wearing a helmet	Mask blocking	Glasses too dark
			

Facial recognition requirement

- Face photo pixel requirement: 70 x 70 pixel or higher
- Detectable face angle: Up and down +/-15 degree, left and right +/-15 degree
- Environment minimum Lux: 450Lux~1,000Lux
- Face detection condition: Eyes, eyebrows, and nose can not be blocked.
- Recognition time: 1 second at 2000 photo db.
- Recognition distance: 0.5M~6M
- Shutter speed of the camera: 1/50 or 1/60 sec or higher
- Facial makeup might affect recognition rate.
- Avoid strong back light environment
- Increase camera brightness if the skin of a face is too dark or the camera faces strong back light.
- Do not use 2.2 mm and 2.8 mm lens due to distorted faces.

Note: Do not use camera IR mode. Black and white video from camera does not work with facial recognition system.

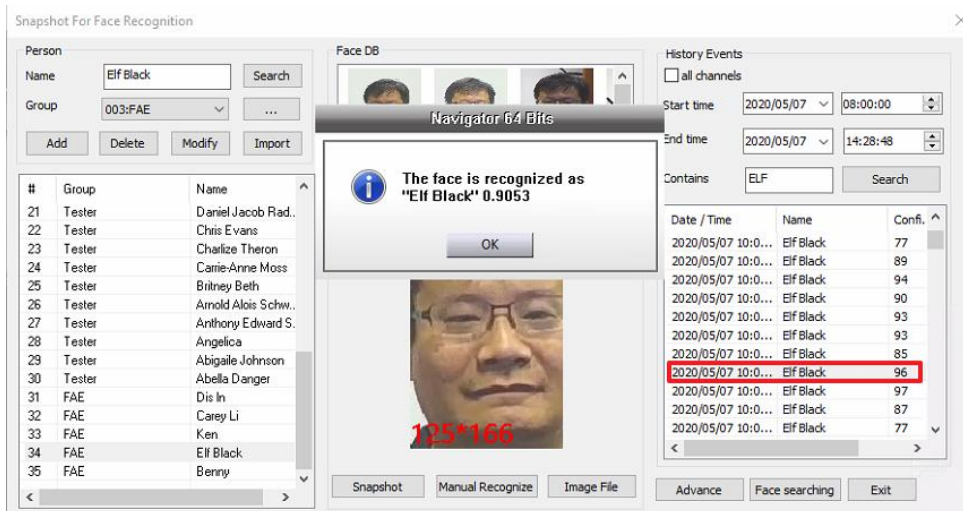

Chapter 21.15 Confidence Rate and Pixel of a Photo

In general, the confidence rate of facial recognition might be affected by the pixel size of a photo. The following table describes examples of confidence rate and pixel size of a photo. However, the confidence rate could be also affected by poor lighting and bad video quality.



The screenshot shows a software window titled "Snapshot For Face Recognition". It features a "Person" section with a search bar containing "Elf Black" and a "Face DB" section with a "Navigator 64 Bits" overlay. A central dialog box displays a message: "The face is recognized as 'Elf Black' 0.9053". Below this is a photo of a man with glasses and the number "125*166" overlaid. On the right, a "History Events" table lists recognition attempts with dates, names, and confidence scores. The entry for "2020/05/07 10:00:00" with name "Elf Black" and confidence "96" is highlighted with a red box.

Date / Time	Name	Conf.
2020/05/07 10:00:00	Elf Black	77
2020/05/07 10:00:00	Elf Black	89
2020/05/07 10:00:00	Elf Black	94
2020/05/07 10:00:00	Elf Black	90
2020/05/07 10:00:00	Elf Black	93
2020/05/07 10:00:00	Elf Black	93
2020/05/07 10:00:00	Elf Black	85
2020/05/07 10:00:00	Elf Black	96
2020/05/07 10:00:00	Elf Black	97
2020/05/07 10:00:00	Elf Black	87
2020/05/07 10:00:00	Elf Black	77

Photo resolution	128 x 114	320 x 310	430 x 430
Confidence	67%	86%	95%
			

Chapter 21.16 Two Phases of Quick Face Photos Setup

For quick face database creation purpose, use Import feature for importing a batch of photos into face database after finishing cameras and NAV setup.

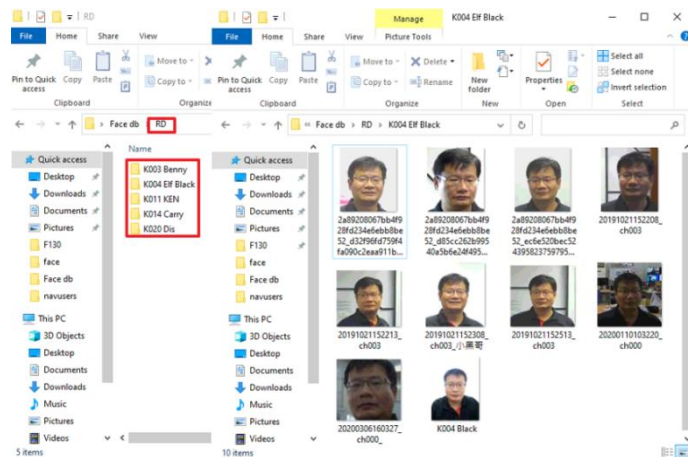

The face database has at least one face photo for a person. Utilizing the facial recognition feature, the camera keeps capture face photos for NAV to recognize. In History Event dialogue box, click Add button for adding the recognized photos for a person. For increasing the recognition rate, at least 5 photos of different angle of a person are highly recommended.

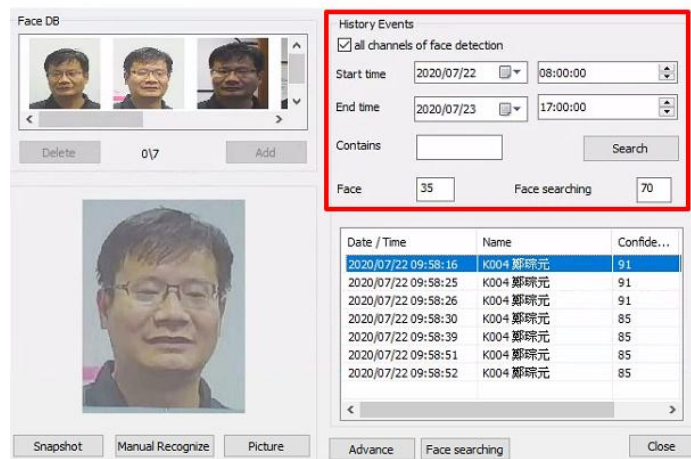

Chapter 21.17 Camera Setting Requirements:

Camera settings for facial recognition are described as below:

1. Shutter speed: To increase recognition rate, set the shutter speed of camera to 1/60 or 1/50 for avoiding video motion blur.
2. AGC: Increase AGC setting for increasing the luminance of the camera.
3. 3D noise reduction: Disable 3D noise reduction to avoid video motion blur.
4. Exposure value: Adjust exposure value for increasing the luminance of the camera.
5. Noise: If the noise of the camera is too high, try lower the sharpness for reducing noise.

Chapter 21.18 Face Recognition Datasheet

Items	Specification
Recognition speed	10-11 recognitions per second for a camera
Number of channels	4 cameras up to 40 recognitions / sec
Number of faces	Up to 4 faces per picture
Minimum face photo pixel requirement	80x80 pixel: 70% confidence rate, 300x300: 80% confidence rate, 450x450 pixel: 90% confidence rate
Detection distance	0.5 ~ 6m, face photo with 80x80 ~ 450x450 pixel
Video resolution supported	720P 30FPS · 1080P 30/60FPS
Maximum people detection allowed	10,000 people, 100 000 photos database
Face training database	10 pictures for a person updatable from the guest list
Recognition rate	Up to 99.82% recognition rate (based on LFW International Facial Recognition Database, database 5000 people, 14000 pictures)
Recognition time	1 second at 2000 photo database
Detectable face angle	Up and down +/-15 degree, left and right +/-15 degree
Environment minimum Lux	450Lux ~ 1000Lux
Face photo database	Batch photos import
Face detected for alarm triggering	Full screen, OSD text, digital output triggering, buzzer, PTZ preset
Face lists	VIP list, unauthorized list, guest list
Guest list	Guest list allows added into face database (training)
Schedule	4 scheduling tables for alarm outputs and DO triggering
Visitor List Recognition Training	The visitor list can be added to the database to increase the recognition rate
Camera supported	ONVIF IP camera and RTSP stream
Video recording	4-ch Navigator 5.0 Corporate license

	Hardware
CPU	I7-10700 or higher (8C/16T)
RAM	32GB DDR4-2400
Graphics	RTX 2060Super or higher
OS	Windows 10 Professional Edition (Version 21H2) and higher
SSD	500GB
HDDs	Up to 3 HDDs for recording
Applications	Access control, time and attendance, surveillance, denial list/VIP greeting management

Note: Do not use local motion detection if facial recognition are activated for reducing CPU loading. Please use remote IP camera motion detection feature if necessary.

Chapter 22 Failover

The Navigator recording server can be configured for failover mode. If one or more Navigator recording servers lose the network connection for cameras or need to be switched off for maintenance purpose, the Navigator recording server (failover server) with failover enabled can record videos for these cameras of Navigator recording servers.

Chapter 22.1 Channel Hot Spare Mode

One failover server can connect to 8 Navigator recording servers for failing over the task.

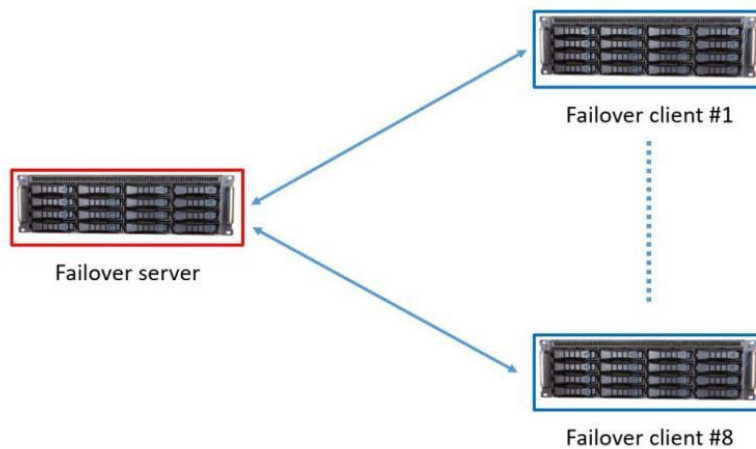

One Navigator failover server can rescue 36 channels of a Navigator recording server. This Navigator recording server cannot accept second failover server, so you have to decide which cameras are very critical for failover feature.



Failover server number of channels cannot exceed its specification where NAV1108 at failover mode can rescue 108 cameras.

Example:

One 108ch at failover mode can only rescue 3 units NAV16108B recorders, each NAV16108B user chooses 36 channels to rescue.

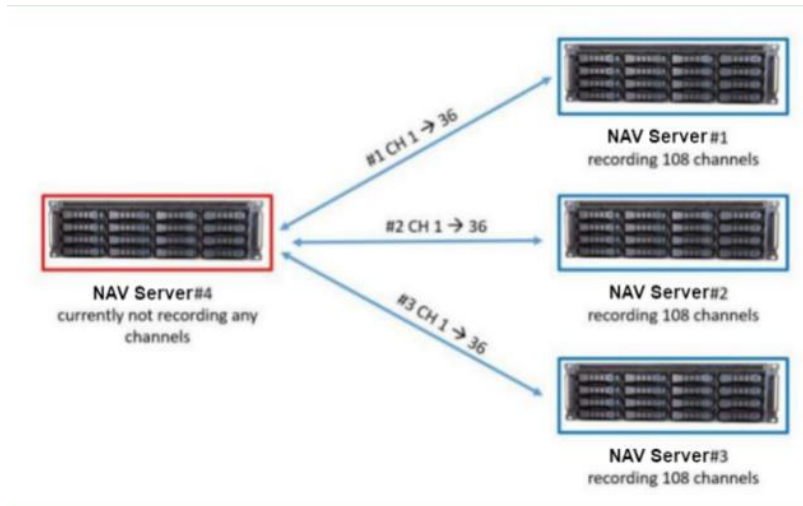

Or one NAV16108B can rescue 8 NAV16108B average 13 channels per server

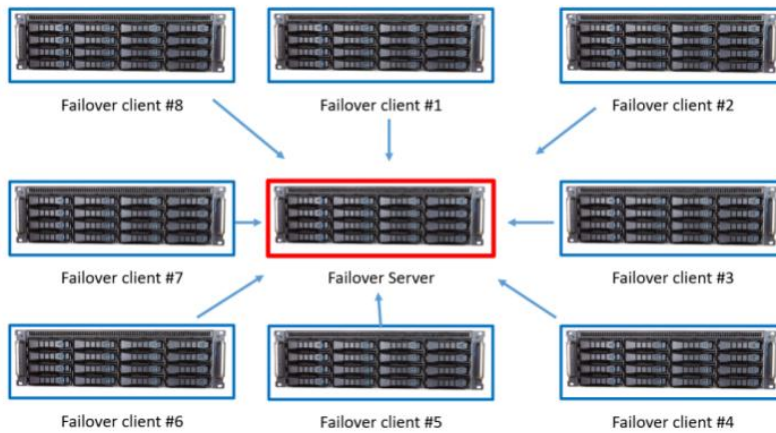

Chapter 22.2 Host Hot Spare Mode

One fault-tolerant migration service host can back up for up to 60 Navigator recording service hosts, and perform fault-tolerant migration video recording services.

When a client disconnects, the channel settings are backed up to the fault-tolerant host. However, only one remote NAV service can be backed up at a time.

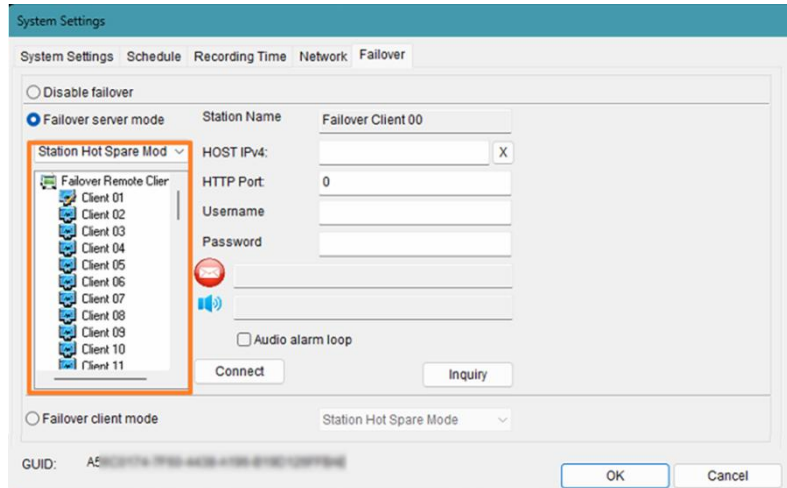

Chapter 22.3 Enable Failover Monitoring Service

To enable failover on the failure over machine, please click System Settings and go to the Failover tab. Select Failover server mode if you want the Navigator recorder to operate as a failover server; select Failover client mode if you want your workstation to operate as a client.

For failover server, choose one of the clients (Navigator recorders) from the list, and specify the host IP address, port number, username, and password to enable the monitoring service. The default port for Navigator is 8021. To enable failure alarm, please select Auto Alarm Loop.

Chapter 22.4 Failover Client Setting

For the Navigator recording server that will be rescued, choose Failover Client mode. Press OK button and re-launch Navigator application.

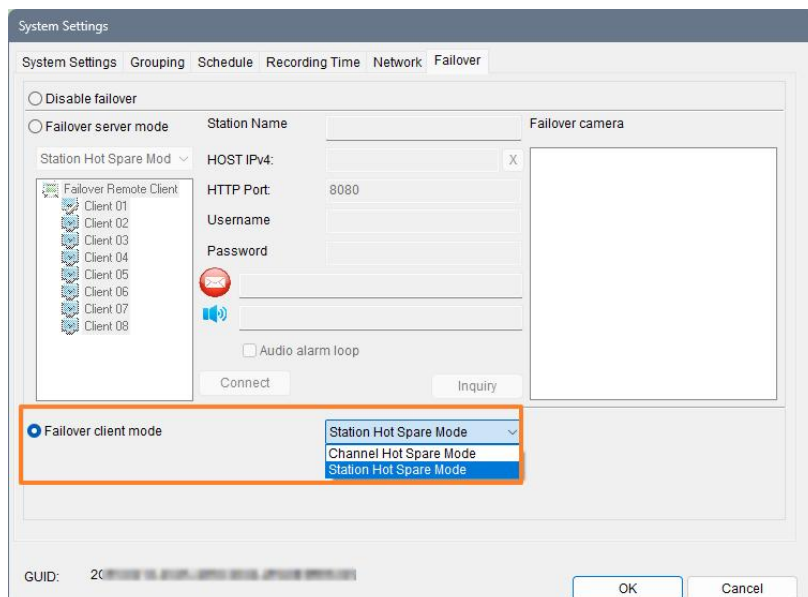

Chapter 22.4.1 Channel Hot Spare Mode

For the failover client (backup host), please check “Failover enabled” in the properties of the camera to be used as the failover client, as shown in the figure below:

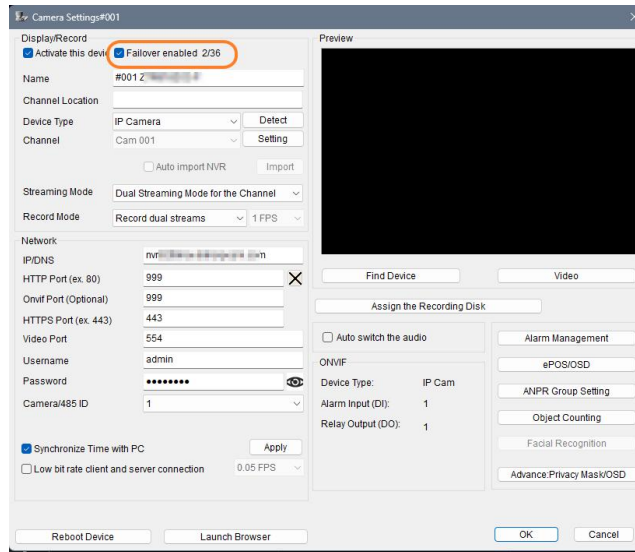

Chapter 22.5 Fault -Tolerant Migration Service Host Setting

For the failover server, please fill in failover client 01, the IP info of the server, which will be rescued, press ok to validate and you will be asked to re-launch the Navigator application

Do the same for the cameras you want to rescue.

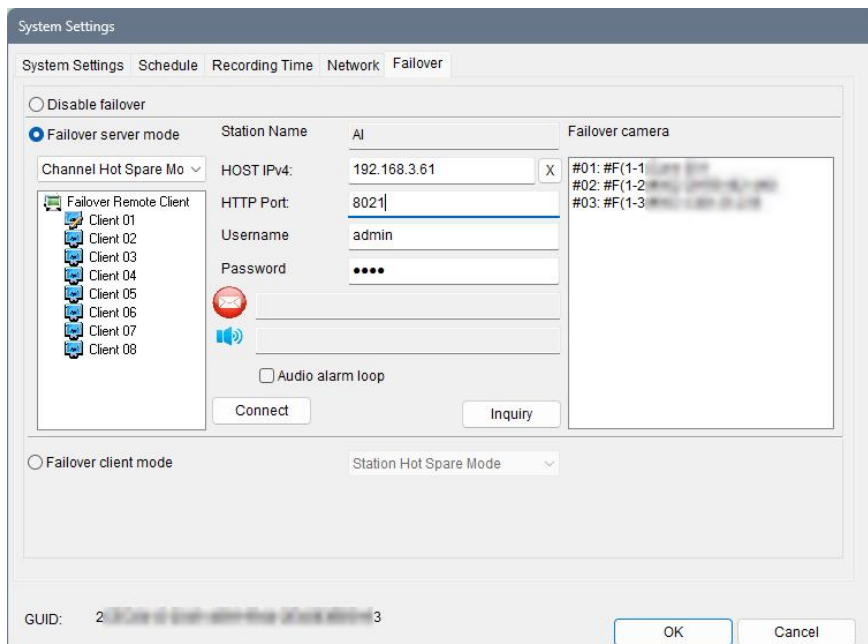

Note: The failover server cannot be used for normal recording, if you had a previous setting on this server, they will be inactive.

In the group page you will see 8 new groups.



After re-launching Navigator, go back to failover setting you will see on the right all cameras selected for failover server.

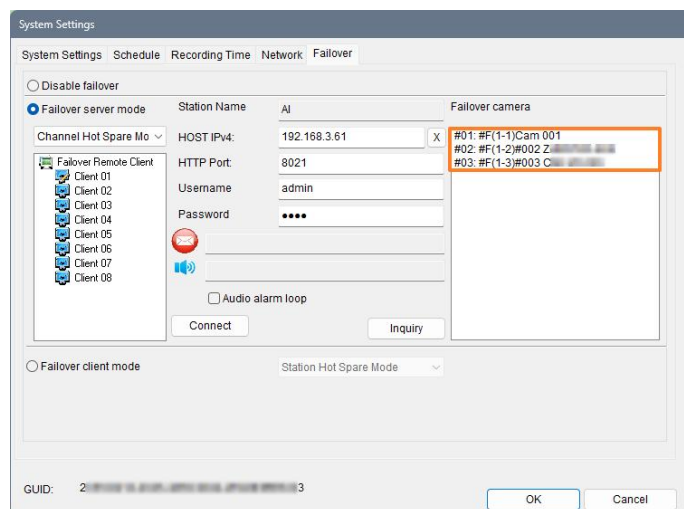

Press inquiry



To test this function, for example, the Navigator recorders (failover clients) suddenly power down at 13:57:00, failover server will start recording selected channel until failover clients are recovered.

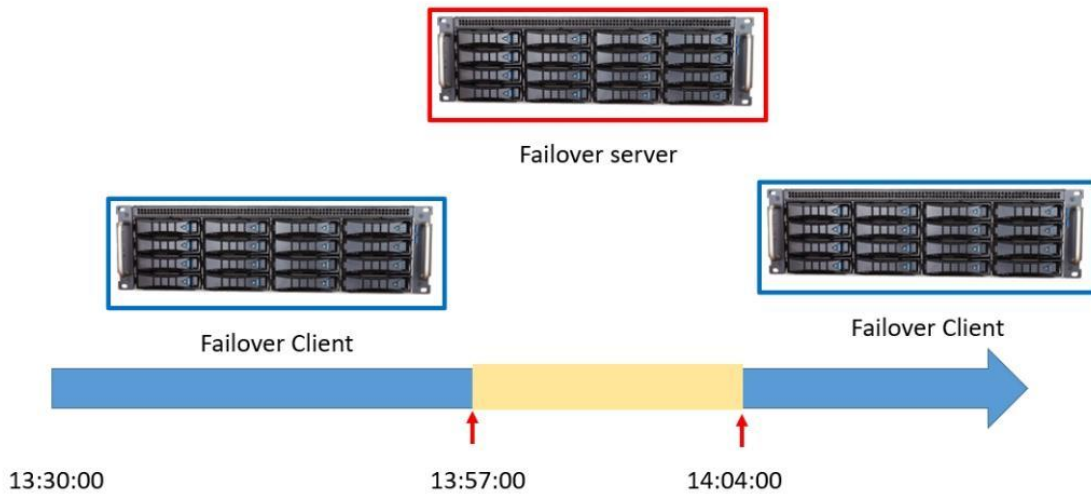

Go to failover server playback interface, you will see a new group

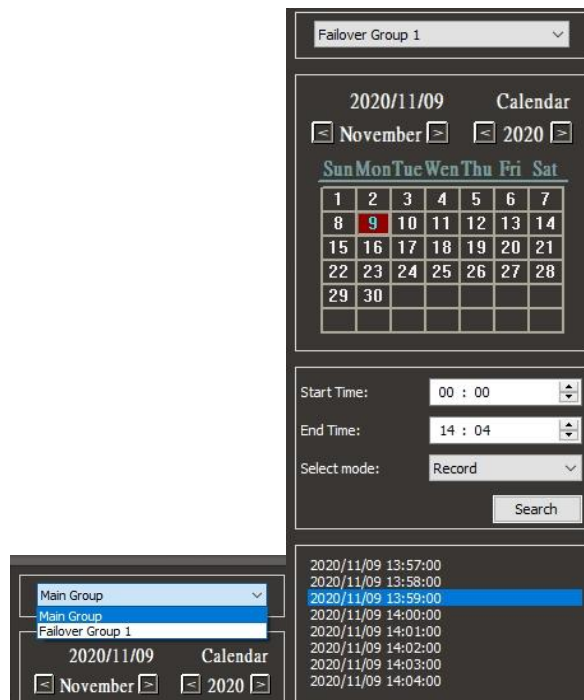

You can now playback data on the server.

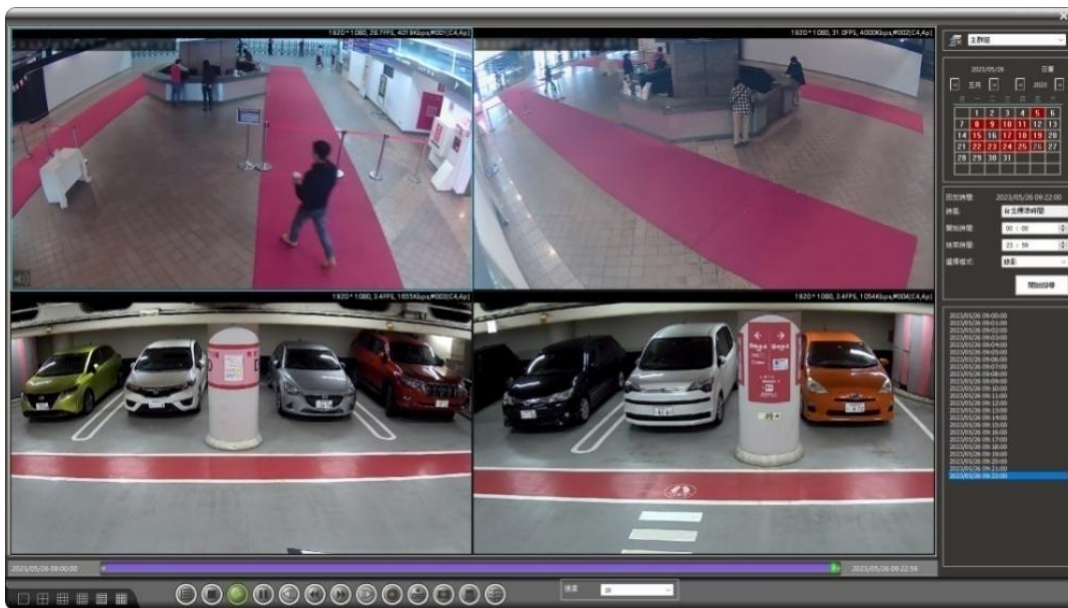

Note: That data on failover server want not be copied to the original failover client, so you need to know at what time the issue happens to check the correct server to find the data.

If you need the failover client has the missing data, you need to use the archive manager function, but it will be very slow and it will backup one channel at a time and also bandwidth consuming.

Chapter 23 Troubleshooting and Support

Chapter 23.1 Choosing between SMR and CMR in Hard Drives

Many people ask what is the right hard drive for the intended use. Because different recording methods have different performance, SMR is used for cold data storage and CMR is used for repeated reading and writing data. Both technologies have their own characteristics for reasonable and right application.

In our guide, it is usually recommended to use CMR hard disks. When the recording host often reads and writes or important data transmission is important, CMR hard disks are a good choice. It is recommended to choose the Pro series of the same model, which can read and write for a long time. To maintain life and warranty, the following are WD and Seagate series hard drives.

For more detailed hard drive model brands, please consult the original manufacturer's technology.

Brand	Model #	Format	Application	RAID 5
WD	Purple Surveillance AI	CMR	DVR&NVR monitoring power saving or small video recording	8 Bay
WD	Red Pro NAS	CMR	NAS RAID small and midsize video recording	16 Bay
WD	Ultrastar DC HC530	CMR	NAS or medium-scale video recording database	16 Bay
WD	Ultrastar DC HC550	CMR	Database and recording a connected large number of channels	24 Bay
WD	Ultrastar DC HC570	CMR	The database is frequently written and read, and JBOD has more channel recordings.	24 Bay
WD	Gold Enterprise	CMR	The database is frequently written and read, and JBOD has more channel recordings.	24 Bay



Brand	Model #	Format	Application	RAID 5
Seagate	SkyHawk AI	CMR	DVR&NVR monitoring power saving or small video recording	8 Bay
Seagate	IronWolf Pro NAS	CMR	NAS RAID small and midsize video recording	16 Bay
Seagate	Enterprise Exos 7E8	CMR	Database and recording a connected large number of channels	24 Bay
Seagate	Enterprise Exos X16	CMR	The database is frequently written and read, and JBOD has more channel recordings.	24 Bay

Note: Technically speaking, SMR also uses a vertical magnetization method, so in order to segregate, the original PMR is renamed CMR.

Note: Depending on the grade or type of the hard disk, the hard disk will decline for a certain period of time when reading and writing, and then return to the normal writing speed. It is generally recommended to use the enterprise-level hard disk of the database to process a large amount of images or retrieving data. In addition, please ensure to keep more than 10% of the reserved space, which aids in buffering hard disk writing.

Chapter 23.2 Computer Room Guidelines

Generally, the computer room should maintain a temperature of $24 \pm 4^{\circ}\text{C}$ and a humidity level of $50 \pm 20\%$. Too high temperature and humidity can lead to component corrosion, shortened lifespan and equipment failure. Clean regularly to reduce dust accumulation and reduce the risk of overheating. Please ensure that these assets are protected from any moisture-related environment.

Chapter 23.3 5.0 System Requirement

The requirements for NAV recorder host and AI recognition server are as follows.

* The number of channels depends on the CPU cache speed. (Simulated scenario calculation: Multiple split screen 480P 15FPS)

Video decoding for the recording host: H.264/265 CPU type.

5.0 NAV Recorder System			
Minimum System Requirements		Basic System Requirements	Recommended System Requirements
Operating System	Win10 Pro 22h2(64 Bit)	Win10 Pro 22h2(64 Bit)	Win11 Pro 22h2(64 Bit)
Processor Frequency	2.4Ghz or higher	2.6Ghz or higher	3.0Ghz or higher
Core Processor	6C/8T or higher	8C/16T or higher	8C/16T or higher
Processor	Intel® Core 10 th i5 or higher	Intel® Core 10 th i7 or higher	Intel® Core 12 th i7 or higher
Recording Channel	36-ch	72-ch	108-ch
Dynamic Recording Channel	16-ch	36-ch	72-ch
Number of AI camera supported	16-ch	36-ch	72-ch
Number of AI Recognition Channel supported	4-ch	8-ch	16-ch
Hard disk Quantity	8 BAY	16 BAY	24 BAY
Built in Graphics Card	Intel® HD Graphics 630	Intel® HD Graphics 730	Intel® UHD Graphics 730
Dedicated Graphics Card	Nvidia GT1030	Nvidia GT1050 or higher	Nvidia GT1050 or higher



AI Video Memory	16GB or higher	32GB or higher	64GB or higher
Video Memory	16GB or higher	16GB or higher	32GB or higher
Dynamic Video Memory	16GB or higher	32GB or higher	64GB or higher
System Disk Space	System SSD 256GB or higher	System SSD 256GB or higher	System SSD 500GB or higher
Database Event Storage	1TB or higher	1TB or higher	1TB or higher
Storage Disk Level	NAS PRO or higher	NAS PRO/Data Enterprise or higher	Data Enterprise or higher
RAID Level	RAID 5	RAID 5, 50	RAID 5, 50
RAID Model	9361-8I 1G or higher	9361-8I 1G or higher	9362-8I 2G or higher
RAID CARD	6 Gb/s or higher	12 Gb/s	12 Gb/s
Internet Connection	1000Mbps RJ45 or higher	1000Mbps RJ45 or higher	1000/10000Mbps RJ45 or higher
Monitor Resolution	1280 X 1024 Minimum Resolution	1920 X 1080 Recommended Resolution	1920 X 1080 or higher

5.0 AI Recognition System					
Minimum System Requirements		Basic System Requirements		Recommended System Requirements	
Operating System	Win10 Pro 22h2(64 Bit)	Win10 Pro 22h2(64 Bit)	Win10 Pro 22h2(64 Bit)	Win11 Pro 22h2(64 Bit)	Win11 Pro 22h2(64 Bit)
Processor Frequency	2.4Ghz or higher	2.6Ghz or higher	2.6Ghz or higher	3.0Ghz or higher	3.0Ghz or higher
Core Processor	6C/8T or higher	8C/16T or higher	8C/16T or higher	8C/16T or higher	8C/16T or higher
Processor	Intel® Core 10 th i7 or higher	Intel® Core 10 th i9 or higher	Intel® Core 10 th i9 or higher	Intel® Core 12 th i7 or higher	Intel® Core 12 th i7 or higher
Recording Channel	4-ch	9-ch	9-ch	16-ch	16-ch
Number of AI Recognition Channel supported	4-ch	8-ch	8-ch	16-ch	16-ch
Database Event Storage	1TB or higher	1TB or higher	1TB or higher	1TB or higher	1TB or higher
Built in Graphics Card	Intel® HD Graphics 630	Intel® HD Graphics 730	Intel® HD Graphics 730	Intel® UHD Graphics 730	Intel® UHD Graphics 730
Dedicated Graphics Card	Nvidia RTX3060 or higher	Nvidia RTX3060 or higher	Nvidia RTX3060 or higher	Nvidia RTX3080 or higher	Nvidia RTX3080 or higher
AI Video Memory	16GB or higher	32GB or higher	32GB or higher	64GB or higher	64GB or higher
Dynamic Video Memory	-	-	-	-	-
System Disk Space	System SSD 256GB or higher	System SSD 256GB or higher	System SSD 256GB or higher	System SSD 500GB or higher	System SSD 500GB or higher
Storage Disk Level	NAS PRO or higher	NAS PRO/Data Enterprise or higher	NAS PRO/Data Enterprise or higher	Data Enterprise or higher	Data Enterprise or higher
Internet Connection	1000Mbps RJ45 or higher	1000Mbps RJ45 or higher	1000Mbps RJ45 or higher	1000/10000Mbps RJ45 or higher	1000/10000Mbps RJ45 or higher
Minimum resolution for object recognition	Up to 120 X 120	Up to 120 X 120	Up to 120 X 120	Up to 120 X 120	Up to 120 X 120
Monitor Resolution	1280 X 1024 Minimum Resolution	1920 X 1080 Recommended Resolution	1920 X 1080 Recommended Resolution	1920 X 1080 or higher	1920 X 1080 or higher

Note:

1. GPU decoder does not support AMD display cards
2. Windows 2012 R2 operating system is not recommended
3. Video recording HDD compatibility table, please contact the original manufacturer technical support.

5.0 Facial Recognition System

4 Monitors System Requirement		6 Monitors System Requirement
Operating System	Win11 Pro 22h2(64 Bit)	Win11 Pro 22h2(64 Bit)
Processor Frequency	2.4Ghz or higher	2.6Ghz or higher
Core Processor	6C/8T or higher	8C/16T or higher
Processor	Intel® Core 10 ^h i7 or higher	Intel® Core 12 th i5 or higher
Face Recognition camera number supported	2ch	4ch
Dedicated Graphics Card	Nvidia RTX2060 or higher	Nvidia RTX3060 or higher
Memory	32GB or higher	32GB or higher
System Disk Space	SSD 256GB or higher	SSD 256GB or higher
Storage Disk Level	1TB or higher	1TB or higher
Internet Connection	1Gbps RJ45 or higher	1Gbps RJ45 or higher
Face Recognition supported channels	Up to 2ch	Up to 4ch
Minimum resolution for object recognition	Up to 80x80 pixels	Up to 80x80 pixels
Camera resolution	1080P between 30 and 60 frames	1080P between 30 and 60 frames
Monitor Resolution	1280 X 1024 minimum resolution	1920 X 1080 recommended resolution

Chapter 23.4 Other Peripheral Hardware Support Table

Hardware Support List	
Supported Device	Supported Model
Our 3D Keyboard	Use USB convert to RS-232/RS-485, PMH-RS485/USB USB to RS-232/485
RS-232 POS System	RS-232 to TCP/IP network supports our 3D Keyboard or RS-232 POS. CYT-100SC RS485/RS232 to TCP/IP Converter
Ethernet Cash Register Drawer	APG-480/APG-490
MOXA Remote I/O Control Box	ioLogik E1210, E1211, E1212, E1214
Embedded Video Decoder	Our Video Decoder
Display Graphics Accelerator	GT 1030 GTX1050/1060 RTX 2060/2080/3050/3060/3070/3080/3090 RTX 4060/4080

Chapter 23.5 Automatically Login In Windows 10& 11

This method applies to Windows 10 account. You do not need to enter your account password each time you turn on your PC. Windows 10 will automatically boot to the desktop.

Please be aware that enabling automatic login makes your computer more convenient to use but anyone can simply turn on the computer and access your personal data, so it's less secure than logging on manually. That needs to be taken into account.

In addition, if it is "System logout" or "Account Lock", you have to enter the password to log in again. Which means this method is suitable for operating system booting only. And it is possible that entering a password is required in other operations.

The areas with unstable power, or Windows updates in the middle of the night, may reboot the system. In order to quickly restore system operation and maintain the LAN connection security, you can apply the following methods.

Note: Navigator 3.0 does not support switching between multiple Windows accounts. Please upgrade to version 5.0.

1. Windows 10 User Account Settings

1. Type **netplwiz** into the Search bar and enter the username account.
2. After open User Accounts, you will see **Users must enter a user name and password to use this computer** option is checked by default. This means a username and password must be entered to log in.

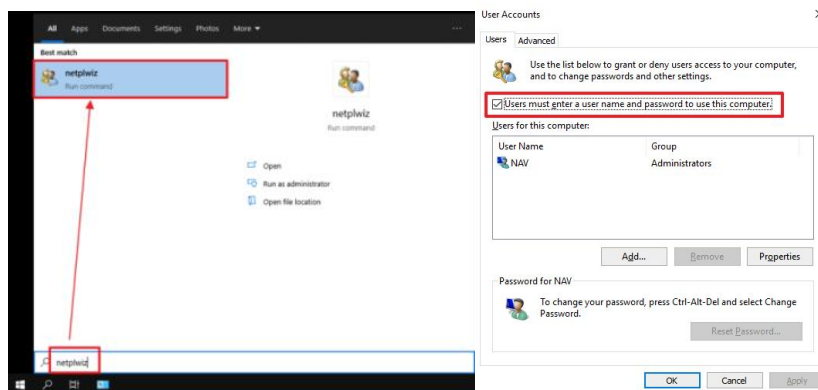

- If "Users must enter a user name and password to use this computer" is not available, the reason is that Windows 1803 is a newer version and Microsoft hides this option. To enable this function, please refer to the following:

- Type **regedit** in the search bar and enter the Register Editor.

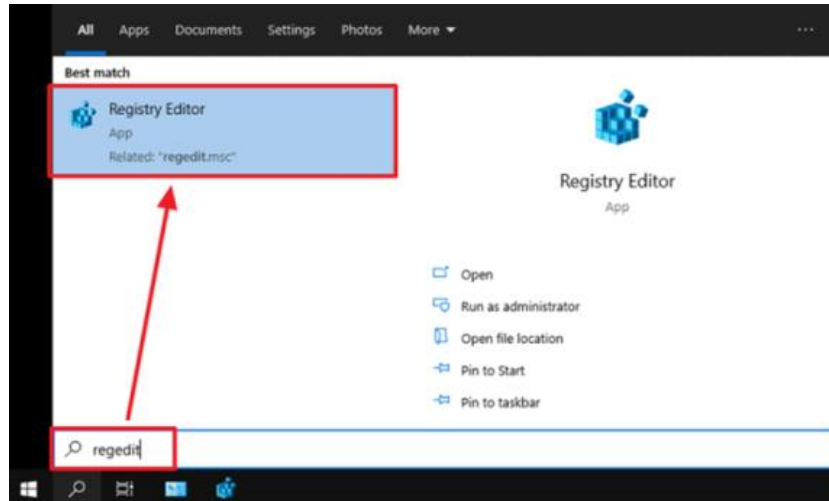

- Navigate to the following path
HKEY_LOCAL_MACHINE\SOFTWARE\Microsoft\Windows NT\CurrentVersion\PasswordLess\Device and change the DevicePasswordLessBuildVersion decimal value to 0.

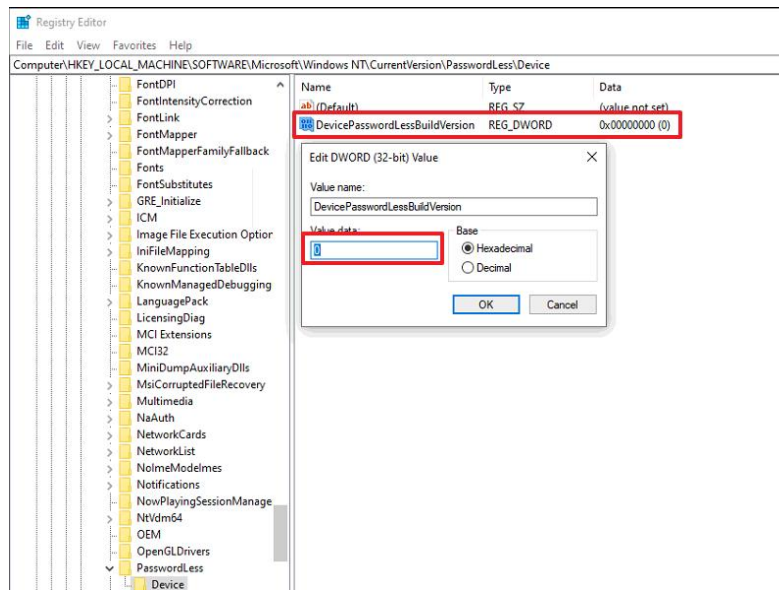

Note: If there is no DevicePasswordLessBuildVersion option, please create DWROD.

- Run "netplwiz" again and Users must enter a user name and password to use this computer option will show up.

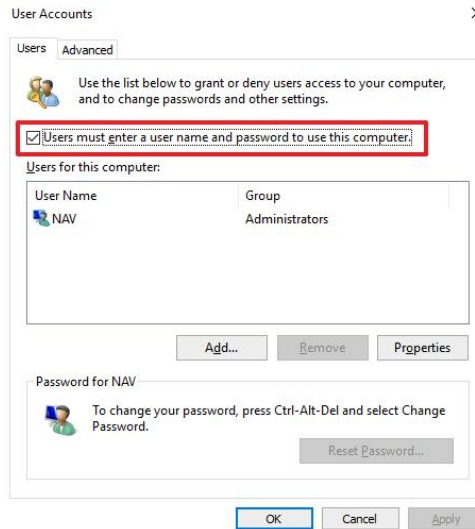

2. Disable and Change User Accounts and Password Settings

For user accounts, please click the **Advanced** tab. Then, click **Advanced** on Advanced User Management.

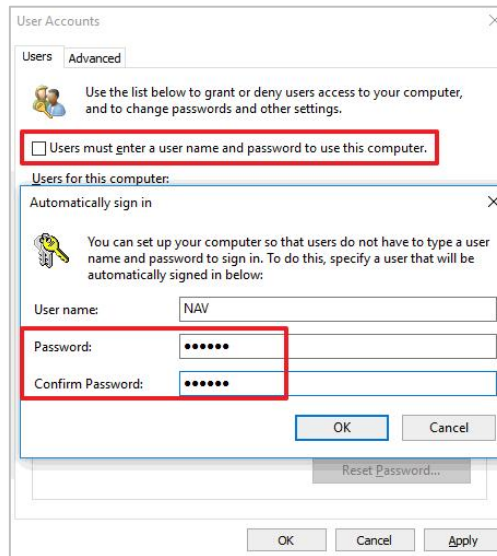

Note 1: NAV host default user account: NAV; password: blank.

Note 2: NAV host has the highest authority by default.

- Click **Advanced**.
- Click **Advanced user management**, and click on **Advanced**.
- Enter **Local Users and Groups**. Then click on **Users** on the console tree.
- Enter the redundant user account and check **Account is disabled**.

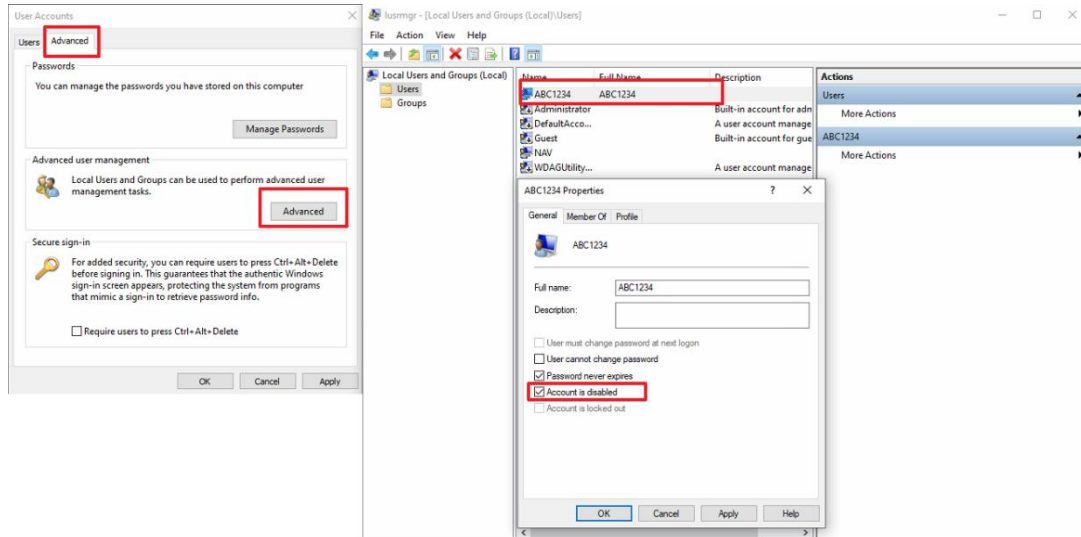

Note 1: Attention! Windows requires at least one set of user account to log in. Disable all accounts will cause Windows login failure.

Note 2: For non-original NAV host users, it is recommended to keep at least one set of user accounts with the highest system administrator authority, and close the other user accounts.

3. User Account Control Settings as Administrator

When only software license or a non-original NAV host is purchased, the user account does not necessarily have the highest privilege. Hence, have to configure the user rights through the following settings:

- Click User Accounts, and click on the Users must enter a user name and password to use this computer check box.
- Click Properties.
- Click Group Membership.
- Select Administrator.
- Click Apply to save the settings.

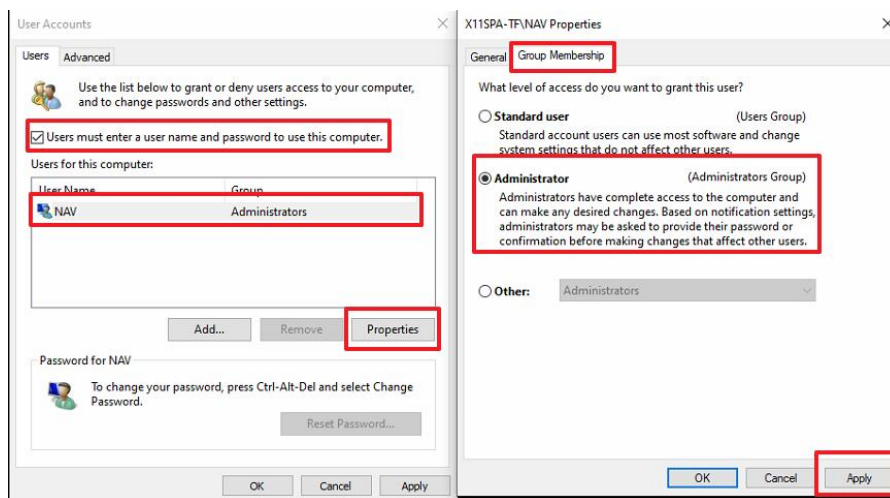

4. Change User Account Name

When renaming the user account name arises, it can be modified as follows:

- Click User Accounts, and click on the Users must enter a user name and password to use this computer check box.
- Click Properties.
- Under General, modify the user name.
- Click Apply to save the settings.

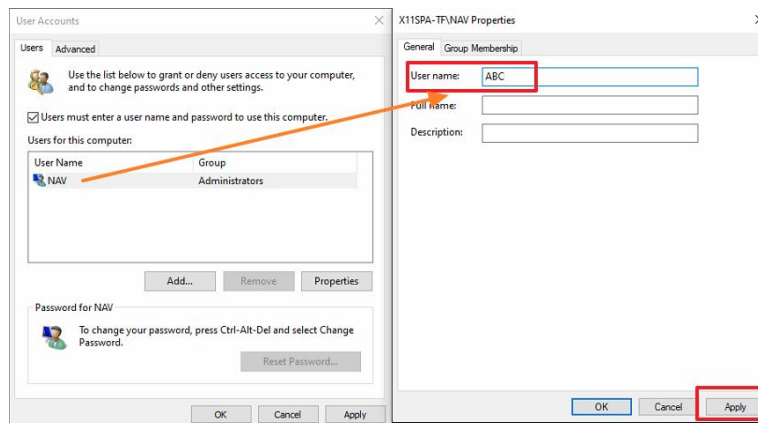

Note: After modifying the user name, make sure to restart the computer. Otherwise, the account cannot be passed to execute some programs (For example: MegaRAID login)

5. Store Username and Password in Computer Settings

- In the User Accounts dialog, select your user account first and then uncheck Users must enter a user name and password to use this computer. Click the Apply button and automatically sign in box pops up.
- Type your password, and then re-enter the password to confirm the same.
- Click OK to save the settings.

The next time the computer restarts, it will remember this set of passwords and automatically log in to the desktop.

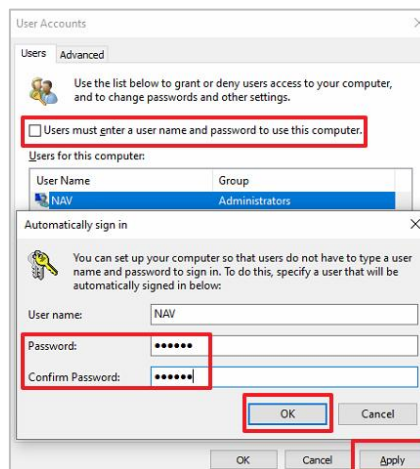

Note: After modifying the user password, make sure to restart the computer. Otherwise, the account cannot be passed to execute some programs (For example: MegaRAID login).

Chapter 24 System Optimization

Chapter 24.1 Windows Change User Account Control Settings

Before installing Navigator on Windows 7 and Windows 10, go to Control Panel → System Security → User Accounts → Change User Account Control Settings and lower the setting to "Never Notify." This will confirm that when the watchdog timer reboots the system, Navigator will automatically open and log in.

Win7 Example:

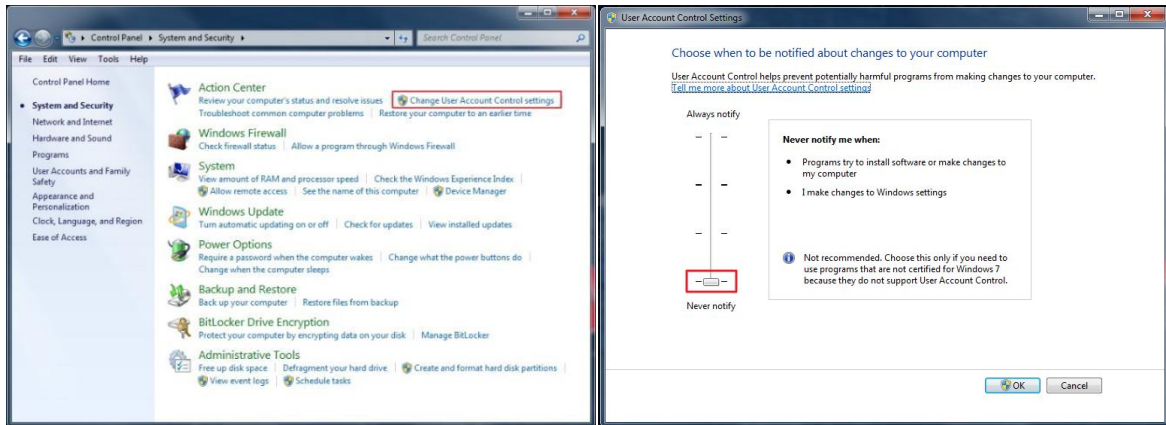

Win10 Example:

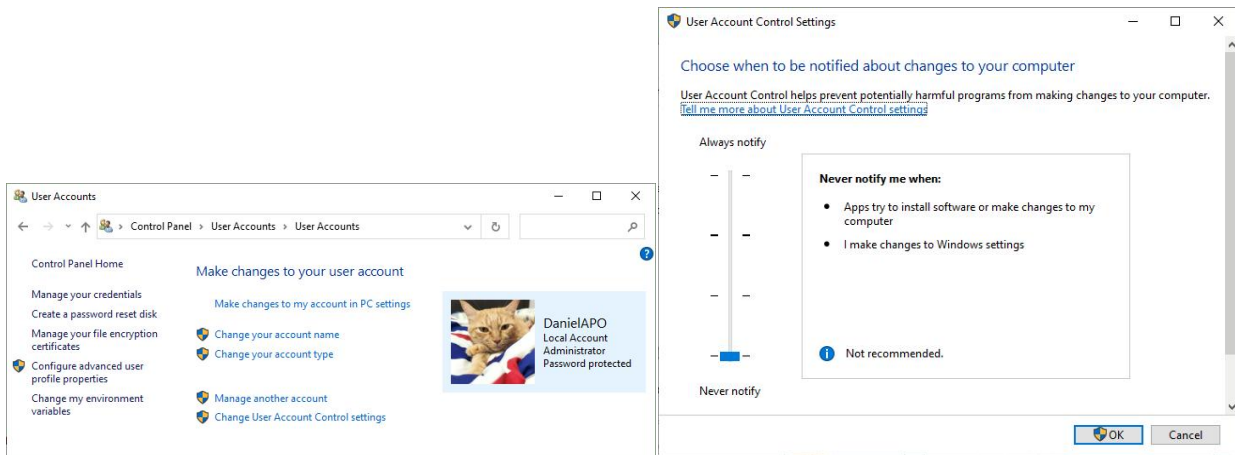

Note: User Account Control (UAC) is a feature in the Windows 7&10 operating system. When user account control is turned on, the application will always run with the security content of a non-administrator account, unless the system administrator specifically grants system access rights at the system administrator level. Otherwise, UAC will prevent the automatic installation of unauthorized applications. To turn off this feature, please set it as follows.

Chapter 24.2 Turn off Hard Drive Defragment

In Windows OS, please go to Control Panel->System and Security->Defragment your Hard Drive->Configure Schedule->Uncheck “Run on a schedule (Recommended)”.

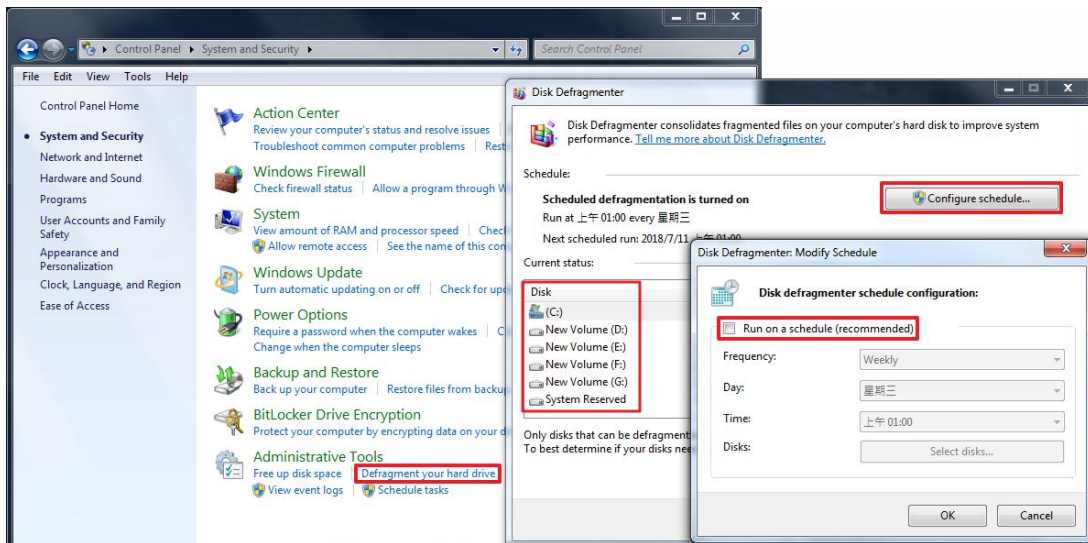

In Windows 10 OS, please go to Control Panel-> Security and Setting-> Defragment and optimize your drives, click on Change Setting and uncheck “Run on a schedule (Recommended)”.

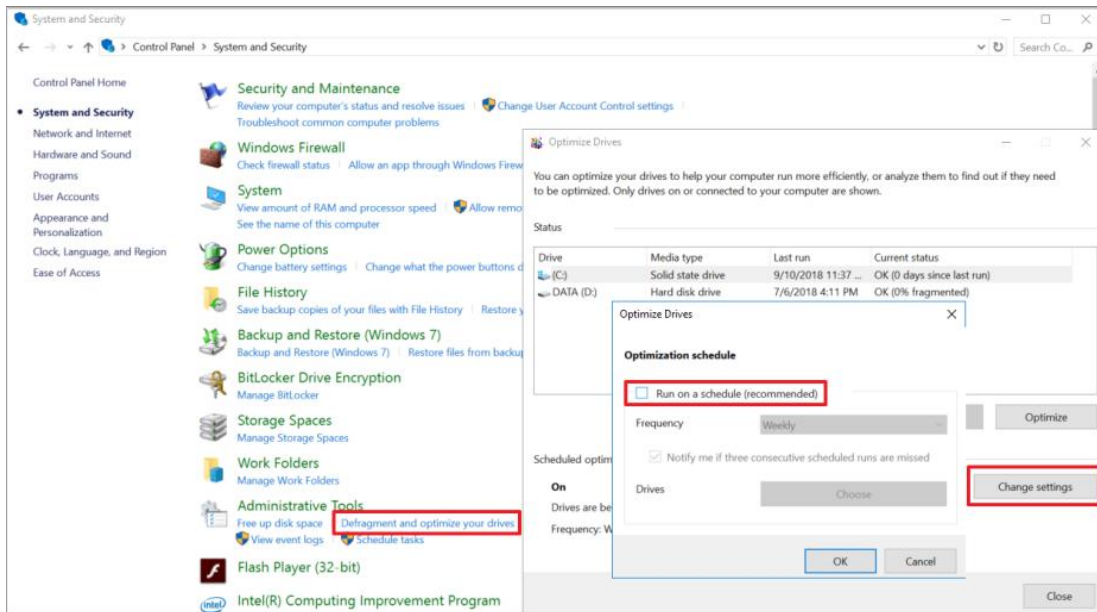

Note: SSD (Solid State Disk) principle is different than traditional HDD. SSD does not have magnetic head and disk does not have physical moving parts latency, when a command gets issued to access a magnetic zone, the circuit can be transmitted as soon as the circuit is turned on. The time required to read any magnetic zone is the same or much faster than traditional HDD, but traditional HDD can configure RAID5/50, there is no need to disk defragment to speed up. Therefore, it is recommended to turn off Hard Hard Drive Defragment to reduce system’s loading.

Chapter 24.3 Turn off creating file content index

The indexing is mainly to establish contents of all computer files into searchable keywords, so as to quickly find the required files. Because the contents of the file are constantly confirmed, the hard disk reading is continuous resulting to high CPU usage rate. Turning off this feature doesn't make it impossible to find the file, it will only look for the name of the file.

Click on the recording HDD and right click → Properties.

Uncheck the checkbox "Allow files on this drive to have contents indexed in addition to file properties" and apply all folders and files.

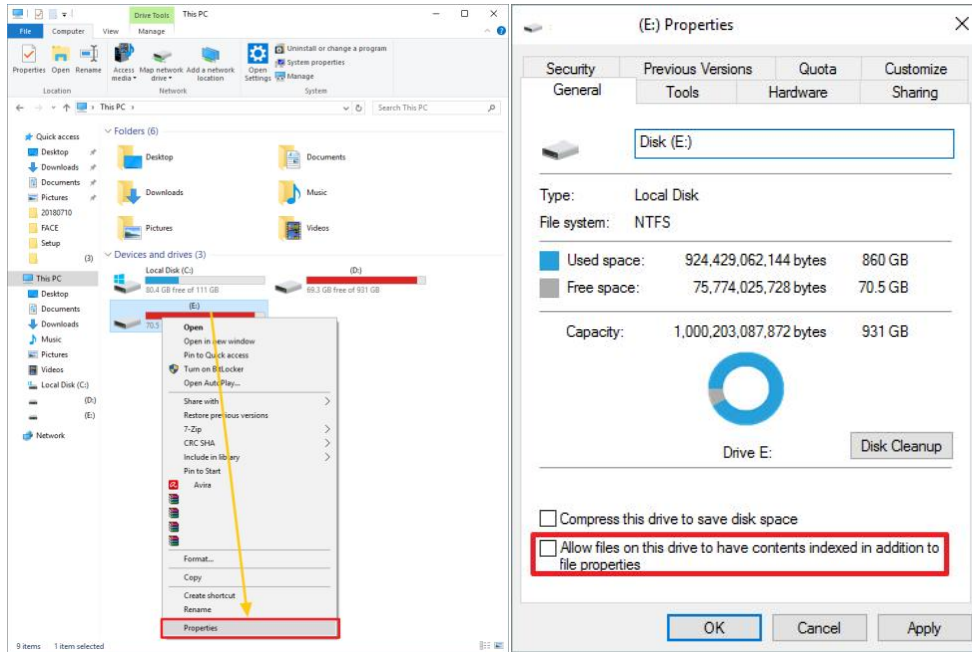

Apply changes to the driver and files.

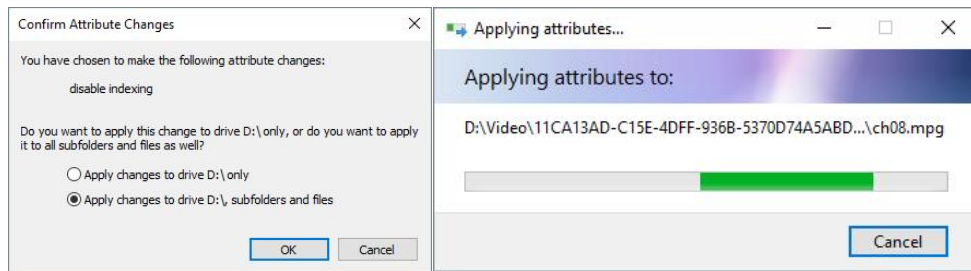

Note: You can apply the changes to the recording disks.

Note: It is recommended to perform this step before planning the system recording. Otherwise the pressure on the hard disk will be increased when the disk index is canceled during recording, which indirectly affects access of the image database from the local or remote.

Chapter 24.4 Turn off Power Saving Mode

In Windows 7&10 Operating System, press Control Panel→System and Security →Power Option

- Put the computer to sleep: set to Never.
- Turn off hard disk after: set to 0.

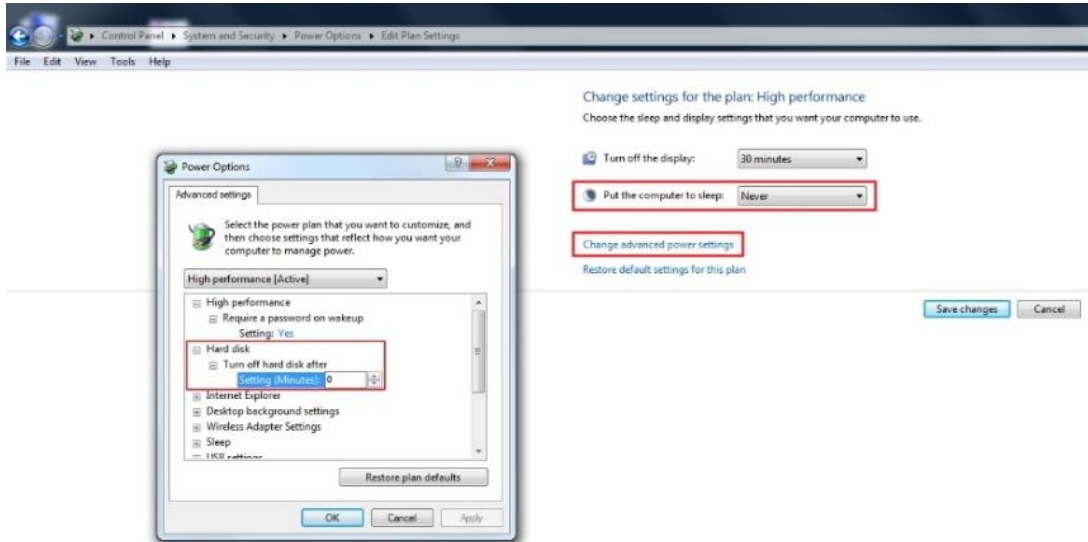

Note: Turn off hard disk time setting can effectively reduce hard disk wake up time.

Chapter 24.5 NVIDIA Graphics Card Maximum Performance

If NVIDIA graphic card is use, mouse right click → NVIDIA control panel→ Manage 3D setting→ Global Settings→ Power management mode→ Prefer maximum performance→ Apply.

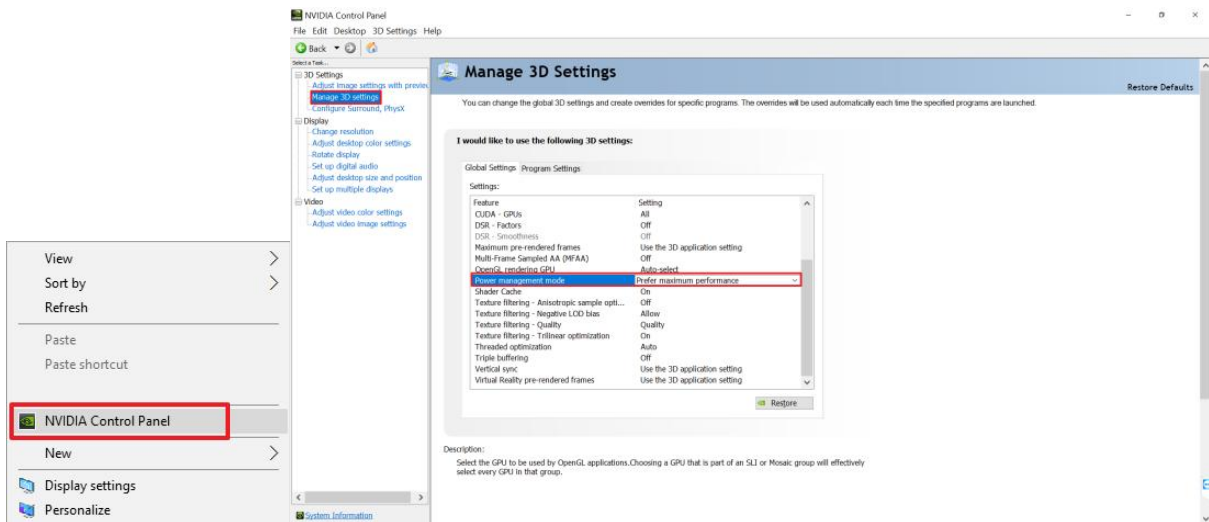

Note: If NVIDIA graphic card driver gets updated, it might restore default automatically.

Chapter 24.6 NVIDIA GeForce Experience

This is used to record and share game videos, and broadcast live on YouTube, Twitch and Facebook. When installing the graphics card driver, please do not install GeForce Experience. For monitoring system stability, there is no need for video streaming and frequent automatic driver update

- Please select manually 【NVIDIA Graphics Driver】 ◦

Chapter 24.7 Set up Windows Manual Update

Windows Server Pack Update is used for maintenance and fixing known security vulnerability issues improving the operating environment. Since the system is recording, to avoid the video instability caused by the system update, it is recommended that the user customize the time maintenance, manually update and restart the computer.



For **Windows 7 OS**, please go to Control Panel→System and Security→Windows Update→Change Setting.

1. Important updates: select “Check for updates but let me choose whether to download and Install them.”
2. Recommended updates: check “Give me recommended updates the same way I receive important updates.”
3. Who can install updates: check “Allow all users to install updates on this computer.”

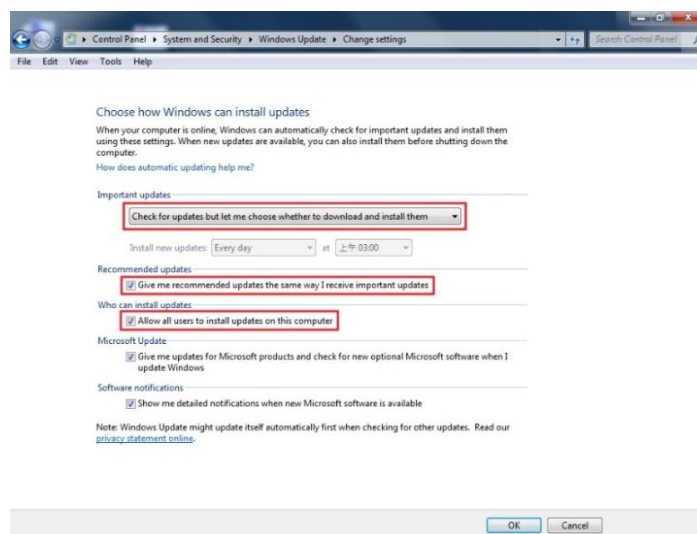

Chapter 24.8 Windows 10 Manually Update Setting

Windows 10 version 1803 or later, after a certain update, the update mechanism is changed. Regardless of whether there is a network or not, it will be automatically reported within 22 hours. The restart mechanism depends on the system Microsoft itself. The original Microsoft provided network services can search common shutdown service method. It cannot completely block the update check process, and must be assisted by the psexec tool.

Note 1: Version Close server 4.6 (Please ask the original manufacturer to request for the technology optimization tool)

Note 2: The optimization tool commands include open update and blocked update purposes. (Only Windows 10 Professional Edition and above is supported, the home version is not supported.)

How to check Windows 10 supported command?

Please press Win+R on the keyboard to open the local group policy editor (gpedit.msc), and then you will have to get permission to modify the Windows update settings.

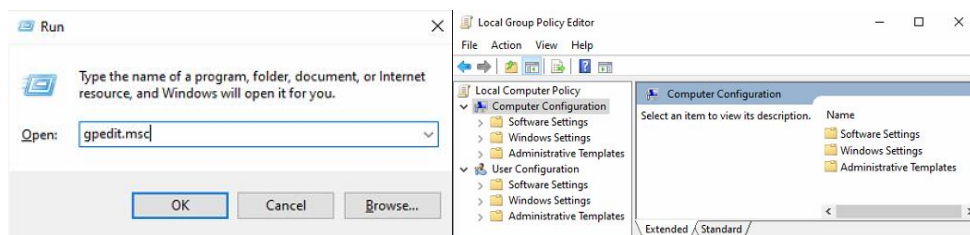

Chapter 24.9 Windows 7/10/11 Update Information

Windows Server Pack Update can update the known security vulnerabilities of Windows systems currently in use to obtain a more secure working environment. Since the system is recording, in order to avoid unstable recording during the system update, it is recommended that users customize the time for maintenance, update manually and restart the computer.

Chapter 25 Windows Update Optimization Function

Chapter 25.1 Close Server Windows

Windows 10, version 1803 and later, after a certain update, the update mechanism has changed, regardless of whether there is a network or not, it will automatically report back within 22 hours. The mechanism of restarting depends on the system Microsoft itself. Previously, the Internet can search for services that are generally closed. In this way, the update check process can no longer be completely blocked, and it must be assisted by the psexec tool.

Version: Close server 5.6

- Download the unzipped file, and copy the psexec folder to C:\navusers (if there is no navusers folder, please create it manually).

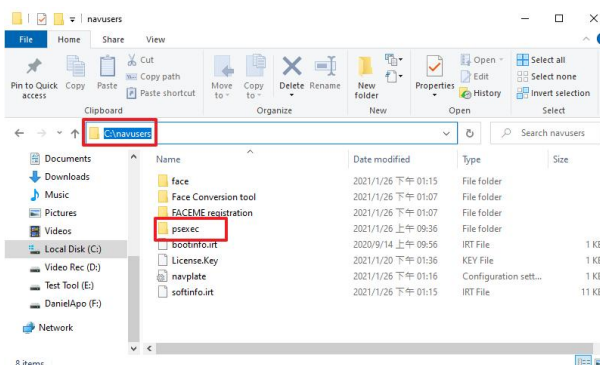

Note: During the program execution, the path and name of the program must not be changed arbitrarily. “Control Panel”->”System and Security”->”Change User Account Control settings”->select “Never notify”.

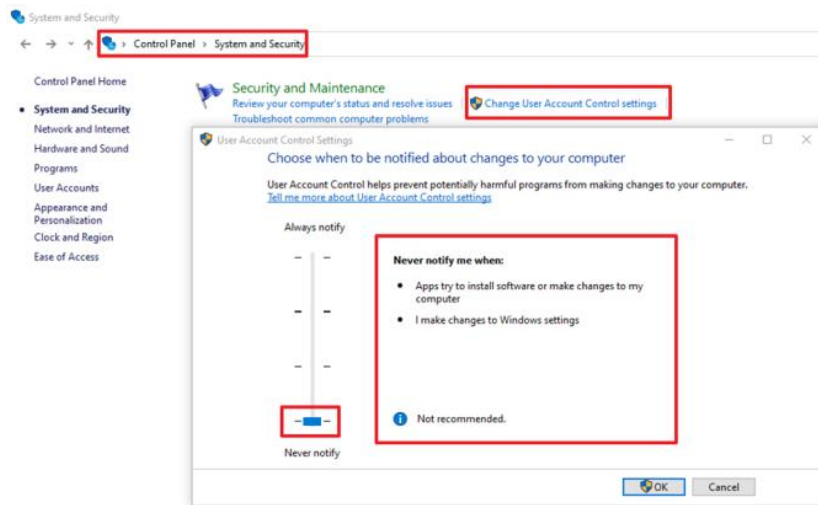

Note: If the UAC permission notification is not skipped first, the program execution may fail due to insufficient permissions.

- Please execute CloseService1, it will take approximately 1~2 minutes, and the optimization program will be executed automatically.

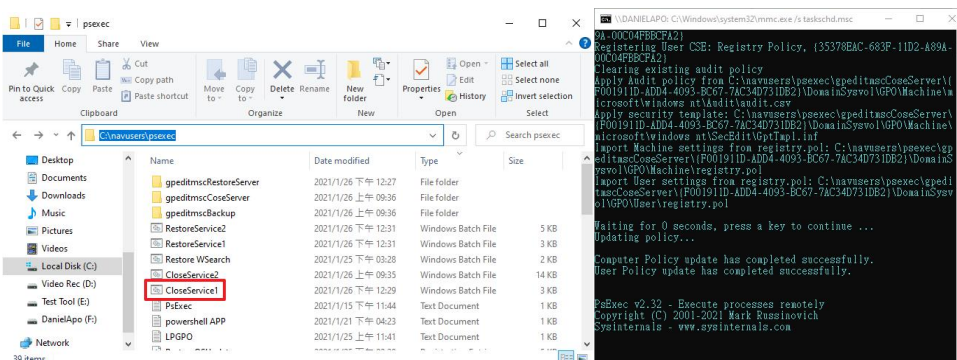

- For users who have never executed the PsExec program before, the first execution will prompt an agreement notification, please click “Agree”.

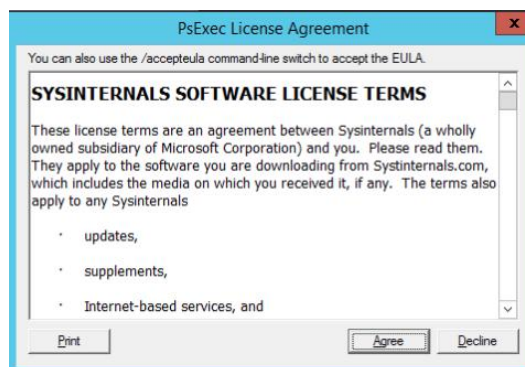

- Afterwards, a window "Task Scheduler" will automatically pop up, please minimize the window and ignore it for now.

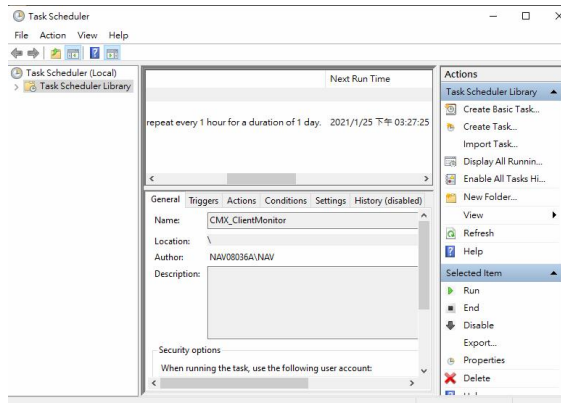

- Please execute "CloseService2", the optimization process will take approximately 1~2 minutes. After the optimization is completed, the program will automatically close the Task Scheduler and "CloseService2".

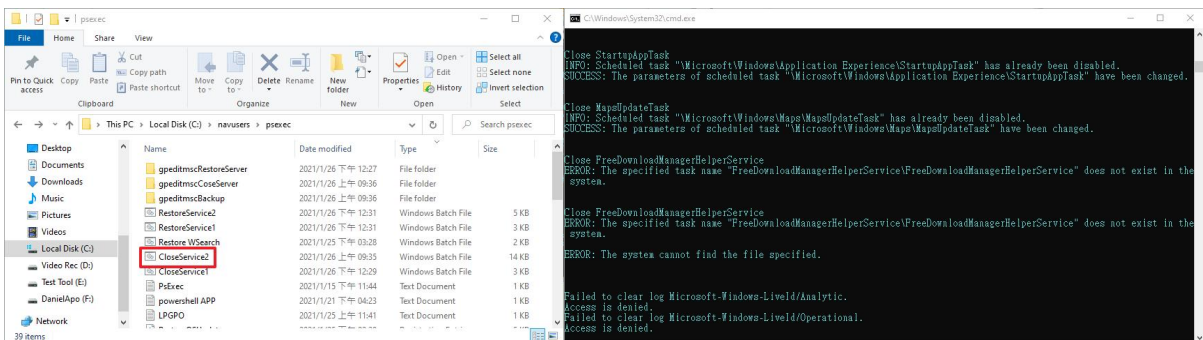

- Due to Microsoft's protection mechanism, the system report function cannot be automatically closed through the batch file for the first time. Please execute CloseService1 again and wait for the Task Scheduler setup to be ready. After completion, restart the computer to complete the optimization process.

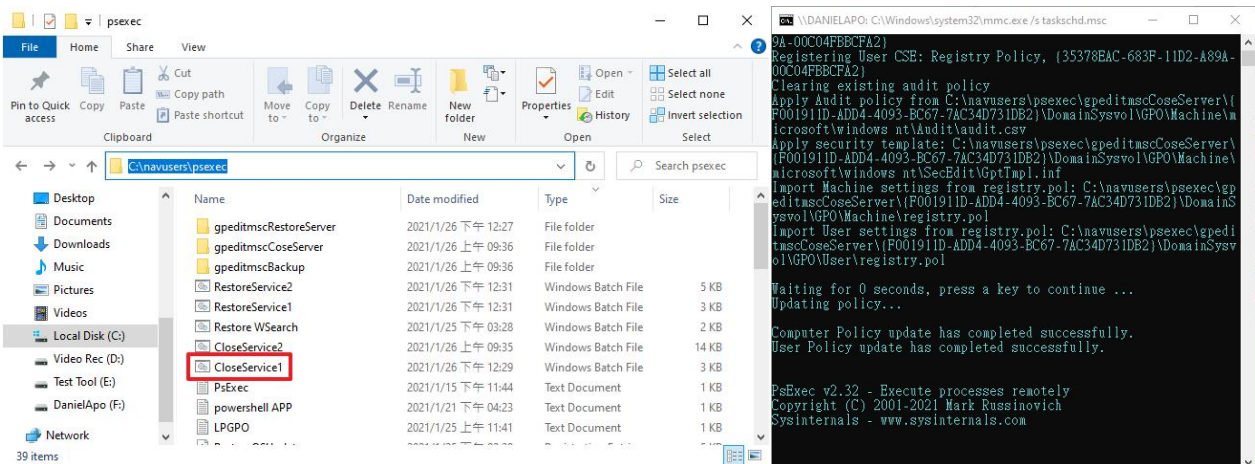

- After the optimization process of the “Close Server” file is completed, search for all program with “Feedback Hub”, right mouse click -> select “Uninstall”.

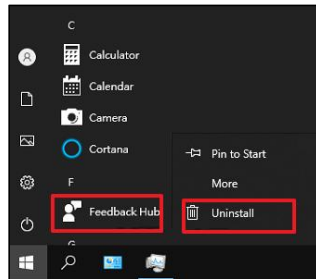

Note: This function is Microsoft's automatic report function.

Chapter 25.2 Restore Server Windows

To restore the Windows Update service and restore the basic default settings, please refer to the following methods:

- Please execute “RestoreService1”, it will take approximately 1~2 minutes, and the restore program will be executed automatically.

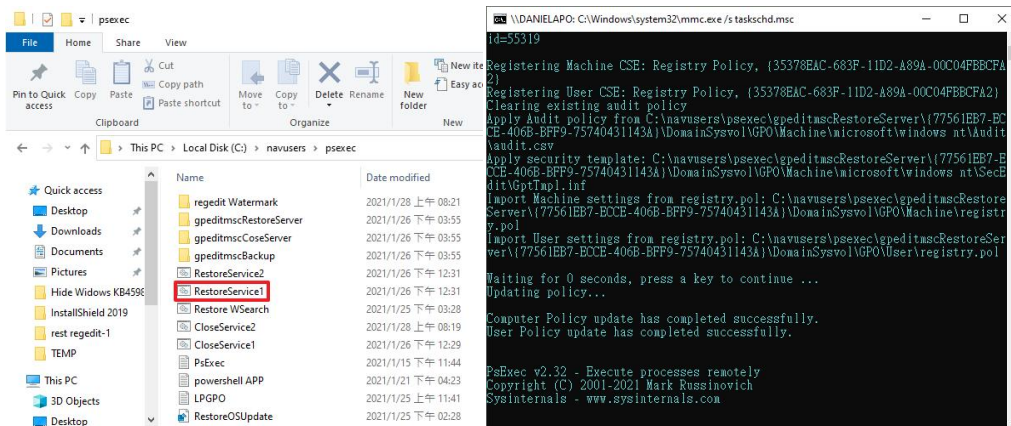

- Please execute “RestoreService2”. It will take approximately 1~2 minutes. After the optimization is completed, the program will automatically close the Task Scheduler and “RestoreService2”. After the completion, restart the computer to end the restoration and optimization process.

